

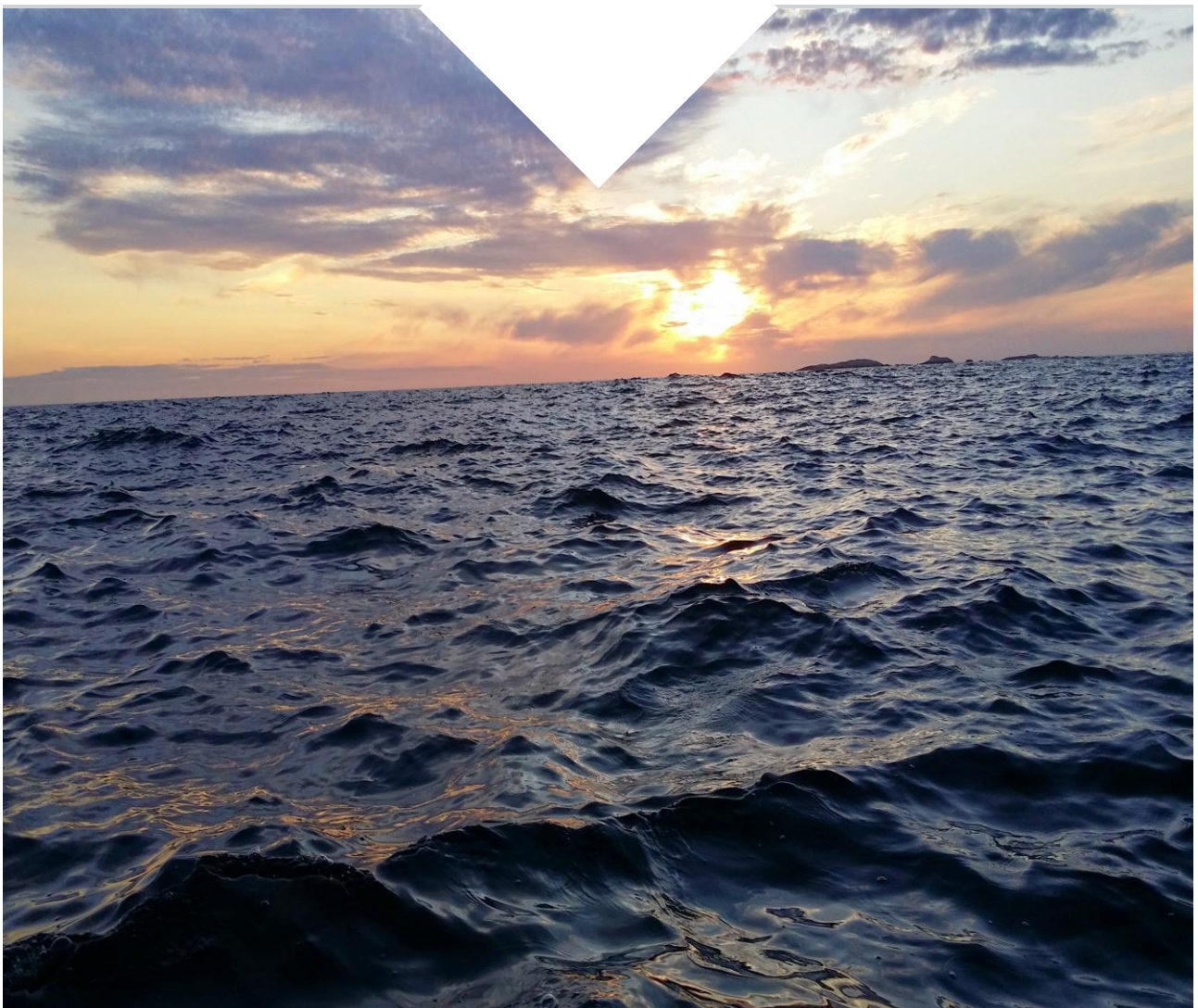

GUIDELINES

M-408 | 2015

Environmental monitoring of petroleum activities on the Norwegian continental shelf



COLOPHON

Executive institution

Norwegian Environment Agency

Project manager for the contractor

Hanne Marie Øren

Contact person in the Norwegian Environment Agency

Mathilde Juel Lind

M-no

M-408

Year

2015

Pages

63

Contract number

Publisher

Norwegian Environment Agency

The project is funded by

Norwegian Environment Agency

Author(s)

Per Erik Iversen, Mathilde Juel Lind, Mihaela Ersvik, Ingeborg Rønning, Bent Barman Skaare, Ann Mari Vik Green, Torgeir Bakke, Rainer Lichtenthaler, Jarle Klungsøyr, Ketil Hylland

Title - Norwegian and English

Retningslinjer for miljøovervåking av petrolemsvirksomheten til havs
Guidelines for environmental monitoring of petroleum activities on the Norwegian continental shelf

Summary

Companies operating on the Norwegian continental shelf are required to carry out environmental monitoring in order to obtain information on the actual and potential environmental impacts of their activities and to give authorities a better basis for regulation. These guidelines are a result of the cooperation between the Norwegian Environment Agency, an expert advisory group appointed by the Agency, oil and gas companies and consultancy firms.

The guidelines serve as a template for how the more general regulatory requirements can be fulfilled. They cover the expected scope of monitoring activities, which parameters should be analyzed and which methods should be used, necessary accreditation and template for reporting.

5 emneord

Miljøovervåking, petrolemsvirksomhet, vannsøyle, prøvetaking, visuelle undersøkelser

5 subject words

Environmental monitoring, petroleum activities, water column, sampling, visual mapping

Front page photo

Norwegian Environment Agency

Foreword

Companies operating on the Norwegian continental shelf are required to carry out environmental monitoring in order to obtain information on the actual and potential environmental impacts of their activities and to give environmental authorities a better basis for regulating releases of pollutants. These guidelines are a result of the cooperation between the Norwegian Environment Agency (the Agency), an expert advisory group appointed by the Agency, oil and gas companies and consultancy firms. Their purpose is to provide detailed instructions on how to meet the general requirements of the HSQ-regulations.

It is crucial for monitoring results and their usability that monitoring is conducted within a clear framework. The results must be comparable over time. In addition, monitoring surveys must generally be conducted in the same way across the whole continental shelf, to be able to compare fields and regions. This is also important because results are reported internationally.

Detailed requirements for environmental monitoring on the Norwegian continental shelf have earlier been comprised by the *Regulations relating to conducting petroleum activities* (the Activities Regulations). These detailed requirements were removed from the Activities Regulations with effect from 1 January 2010 and incorporated into the present guidelines, which were last revised in January 2013 (TA 2848/2011).

These are some of the major changes made in this revision of the guidelines:

- We have made extensive changes in the regime for the water column monitoring. Changes entail inter alia that the Agency now recommends conducting surveys of a larger extent every three years, rather than smaller scale ones yearly. The field surveys will still comprise organisms held in cages and wild caught organisms, but the terms “effect monitoring” and “condition monitoring” are no longer in use. The approach will also provide better time for further method development in the period between two field surveys.
- We have added a chapter on visual surveys of benthic habitats (and the seabed) with more detailed requirements for carrying out and reporting the results of such surveys.
- We have detailed/clarified sampling and analysis requirements for monitoring of benthic habitats (sediments and fauna). The following are among the biggest changes:
 - We have replaced the analytical parameter total organic matter (TOM) with total organic carbon and possibly total nitrogen (TOC/TN)
 - We have replaced some of the recommended indexes for soft bottom fauna
- We are asking that the area with significant sediment contamination is also calculated for THC higher or equal to 50 mg/kg if possible.
- We have refined and reinforced our requirements for quality control.
- We have removed requirements for sampling and analysis of wild caught radioactive substances, which are managed by the Norwegian Radiation Protection Authority.

The document includes a series of other corrections, such as typos, clarifications of ambiguous language or refinement of existing requirements.

Signe Nåmdal

Director of the Industry and Marine Environment Department
Norwegian Environment Agency, Oslo, June 2015

Content

| | |
|---|-----------|
| Foreword | 3 |
| 1. Introduction | 6 |
| 1.1 Purpose of the environmental monitoring | 6 |
| 1.2 Monitoring requirements | 6 |
| 1.3 Purpose of these guidelines | 7 |
| 1.4 Developing monitoring programs and cooperation | 7 |
| 1.5 Description of the monitoring regimes | 8 |
| 1.5.1 Monitoring of the water column | 8 |
| 1.5.2 Monitoring of benthic habitats (sediments and soft- and hard-bottom fauna) | 9 |
| 1.6 Quality assurance..... | 10 |
| 2. Definitions and abbreviations | 11 |
| 3. Water column monitoring | 15 |
| 3.1 Time frame | 15 |
| 3.2 Monitoring frequency and sampling design | 15 |
| 3.3 Organisms to be monitored..... | 16 |
| 3.4 Analytical parameters | 17 |
| 3.5 Sample collection and processing | 19 |
| 3.6 Analytical methods..... | 20 |
| 3.7 Further development of methods | 20 |
| 3.8 Reporting | 21 |
| 4. Monitoring of benthic habitats (grab sampling surveys) | 24 |
| 4.1 Time frame | 24 |
| 4.2 Survey frequency and sampling design | 25 |
| 4.3 Station network..... | 28 |
| 4.3.1 Selection of stations for baseline surveys..... | 28 |
| 4.3.2 Selection of stations for follow-up monitoring surveys..... | 30 |
| 4.4 Analytical parameters | 31 |
| 4.4.1 Sediment appearance on sampling | 32 |
| 4.4.2 Physical and chemical sediment analyses..... | 33 |
| 4.4.3 Biologisk karakterisering | 34 |
| 4.5 Sample collection and processing | 35 |
| 4.5.1 Sample collection | 35 |
| 4.5.2 Sample storage..... | 36 |
| 4.5.3 Etablering og lagring av biologisk referansemateriale | 36 |
| 4.5.4 Analytical methods..... | 36 |

| | | |
|-----------|--|-----------|
| 4.5.5 | Physical and chemical sediment analysis | 36 |
| 4.5.6 | Biological characterization | 38 |
| 4.5.7 | Processing of biological data | 39 |
| 4.5.8 | Estimation of affected area | 40 |
| 4.6 | Reporting | 40 |
| 5. | Monitoring of benthic habitats (visual surveys)..... | 46 |
| 5.1 | Time frame | 46 |
| 5.2 | Recommended equipment | 46 |
| 5.3 | Survey strategy and choice of survey lines | 47 |
| 5.3.1 | Surveys where the spud location is not known..... | 47 |
| 5.3.2 | Surveys where the spud location is known..... | 48 |
| 5.3.3 | Detailed surveys | 49 |
| 5.4 | Survey methodology for different fauna groups | 49 |
| 5.4.1 | Corals..... | 49 |
| 5.4.2 | Sponge communities | 50 |
| 5.4.3 | Sea-pen communities..... | 51 |
| 5.5 | Analysis of collected material | 52 |
| 5.6 | Reporting | 52 |
| | References | 55 |
| 6. | Appendices | 57 |
| | Appendix I - Analytical parameters..... | 57 |
| | Appendix II - Modified van Veen grab for collecting sediment samples | 57 |
| | Appendix III - Detection limits for metals | 59 |
| | Appendix IV - Formula for calculating LSC | 60 |
| | Appendix V - Methods for delimitating affected areas..... | 60 |
| | Appendix VI - Recommended equipment for carrying out visual surveys..... | 61 |

1. Introduction

1.1 Purpose of offshore environmental monitoring

The purpose of offshore environmental monitoring is to provide an overview of the environmental status and of trends over time seen in relation to offshore oil and gas activities. Monitoring is intended to indicate whether the environmental status on the Norwegian continental shelf is stable, deteriorating or improving, due to operators' activities. In addition to identifying trends, the results should as far as possible provide a basis for projections for future developments.

Environmental monitoring of offshore oil and gas activities includes monitoring of the water column and of benthic habitats (sediments, soft-bottom fauna and hard-bottom fauna). Operators and authorities use monitoring results as a source of information and as grounds for decision making regarding new measures to be implemented offshore. The results are also used to develop and report on national environmental indicators for the offshore oil and gas industry. In addition monitoring results are reported to the Norwegian Ministry of Climate and Environment and to international bodies such as OSPAR.

1.2 Monitoring requirements

Under section 49 of the Act of 13 March 1981 No. 6 concerning protection against pollution and concerning waste ([Pollution Control Act](#)), any person that causes pollution has a duty "to provide the pollution control authority or other public bodies with any information necessary to enable them to carry out their tasks pursuant to this Act". Further, under section 51 of the Act, the Agency have the power to order investigations to "determine whether and to what extent the activity results in or may result in pollution". Specific requirements relating to environmental monitoring are set out in sections 52-56 of the Activities Regulations for the oil and gas industry, which deal with environmental surveys of the water column and benthic habitats, and cooperation between operators within the same region. The scope of the monitoring must be proportional to the expected risk.

Authorities can carry out inspection and control of environmental monitoring activities, in the same way they do for other activities regulated by environmental legislation. This applies to all stages, from planning of the surveys to the use of the results by individual operators to improve their environmental performance.

Operators must contact the Agency if they're unsure whether conducting a baseline survey in connection with new activity is required cf. Activities Regulations § 53. This may for example apply to exploration drilling in the North Sea / Norwegian Sea and exceptionally in the Barents Sea. The areas should be well investigated, and knowledge that vulnerable benthic fauna is not present in the area should be available. Operators should present an overview of

the available data for the area and state why they do not consider a baseline survey necessary.

1.3 Purpose of monitoring on the Norwegian continental shelf

Detailed requirements for environmental monitoring on the Norwegian continental shelf were previously included in the Activities Regulations. As part of the legislation simplifying process and in order to provide more flexibility when changes were needed, the detailed descriptions of monitoring procedures have been transferred from the regulations to the present guidelines. The regulations now contain general requirements, while the guidelines provide more detailed instructions on how the requirements can best be met.

The guidelines describe the required scope of the monitoring activities, the parameters that are to be analysed, the methods that should be used, necessary accreditation, and templates for reports.

1.4 Developing monitoring programs and cooperation

Operators in a region where monitoring is planned are responsible for drawing up draft programmes for monitoring of the water column (either field surveys or method development) and of the benthic habitats in the region. The Norwegian Oil and Gas Association (NOROG) has its own environmental monitoring expert group which coordinates the planning, implementation and reporting of environmental surveys on behalf of the operators. Operators are required to build their environmental monitoring programmes on the requirements of the regulations and on the instructions given in these guidelines. The Agency, an expert advisory group appointed by the Agency, NOROG and relevant operators present, discuss and assess the draft programmes at annual planning meetings. Consultants may also take part in these meetings if needed. The scope of the final programme is decided upon based on discussions at these meetings. The operators make the necessary corrections to the draft and send the final programme to the Agency. This cooperation to determine the final content of environmental monitoring programmes makes it possible to review both positive and negative experiences gained from earlier surveys.

It may be appropriate to require additional monitoring surveys in certain areas, for example in nearshore waters or in areas where vulnerable species and habitats have been identified or there is reason to believe they may occur. The operators are responsible for identifying the need for additional surveys. Plans for such surveys are drawn up by the operator(s), in consultation with the Agency and relevant working groups in the NOROG, in line with the risk profile of the discharges.

Environmental monitoring includes investigation of radioactivity. Plans for these surveys are drawn up by operators in consultation with the Norwegian Radiation Protection Agency, before the above-mentioned annual planning meeting.

A forum for offshore environmental monitoring is held annually. This is a working meeting where operators and consultants are invited to present the most recent results (from the previous year's surveys), as well as plans for future monitoring. The forum also provides an opportunity for lectures and discussions around current issues related to offshore environmental monitoring. The forum is organised alternately by the Agency and NOROG.

1.5 Description of the monitoring regimes

1.5.1 Monitoring of the water column

Section 55 of the Activities Regulations stipulates that monitoring of the water column must be carried out in connection with offshore oil and gas activities. The monitoring is intended to document whether and to what extent organisms in Norwegian waters are affected by pollution generated by oil and gas activities. The requirement to conduct monitoring of the water column is not solely related to produced water discharges, but includes relevant chemical additives and seeps or leaks from the seabed, as well as any other relevant discharges.

The scope of the monitoring is determined by the Agency. It is recommended to carry out field surveys/campaigns of a larger extent every three years, rather than smaller scale ones yearly. This is believed to be more cost effective. This approach ensures at the same time that the scope of the monitoring is proportional to the expected risk.

The Agency and relevant operators decide which area(s) are to be surveyed. The monitoring surveys should include hydrographical measurements, chemical analyses and investigations on field transplanted organisms held in cages and wild caught organisms.

Passive samplers and organisms held in cages are placed on instrument rigs in the surveyed area. The positioning of the instrument rigs is chosen on the basis of dispersal models for relevant components of the discharges, including added chemicals. In order to obtain better information on dispersal instrument rigs should be placed in all directions from the discharge point.

Investigations of wild caught organisms include pelagic and demersal species that live in the surveyed area. Sampling of wild caught organisms is based on available and updated knowledge on the occurrence, distribution and migration patterns of the relevant fish stocks in the area.

As part of the environmental monitoring regime, operators are required to contribute to method development with the purpose to improve monitoring of the water column cf. § 52 of the Activities Regulations. Carrying out field surveys every third year will allow for new methodology to be developed and qualified in the period between two field surveys. The Agency expects that the scope of future field investigations will be greater than that of previous ones since these will take place every three years instead of annually. This may mean that a larger area, with several installations, will be covered, or that several analysis parameters are to be included.

If the Agency considers it necessary, further investigation of the water column with respect to environmental conditions and effects of discharges in the fields' neighboring areas may be required cf. § 52 and 55 of the Activities Regulations. Such studies may be initiated as agreed upon by the Agency and relevant operators.

1.5.2 Monitoring of benthic habitats (sediments and soft- and hard-bottom fauna)

According to §§ 53 and 54 of the Activities Regulations, monitoring of benthic habitats consists of two main elements:

- **Baseline surveys**, which are required before exploration drilling in new areas, in areas where vulnerable benthic species and habitats occur or in areas where there is reason to believe these may occur, and before production drilling.
- **Regular field-specific and regional monitoring surveys**, which normally begin after production drilling has started. Field-specific monitoring surveys are part of the regional program, and are carried out at the same time.

The Norwegian continental shelf is divided into eleven geographical regions for monitoring of benthic habitats (see Figure 4.1). As a general rule, each region should be surveyed every third year, and the surveys should alternate between regions. The scope of the monitoring programmes must be proportional to the level of offshore activity in the region. Monitoring of new activities is additional to and must be adapted to existing monitoring activities. If large variations in depth and/or type of sediment indicate that it is necessary, regions should be divided into subregions. The subregional divisions established in regions that have already been surveyed should not be changed without good reason.

Samples from the regional and field-specific stations in one region are to be taken during the same survey. The regional stations are intended to provide information on general background levels in the area for the parameters that are monitored and to function as reference stations for the expected normal situation. The field-specific stations are intended to provide information on the environmental status near the facilities in each region. Samples should primarily be analysed for petroleum hydrocarbons, metals, wild caught radioactive substances, as well as sediment and fauna composition.

Monitoring of the vertical extent of contamination should be done when necessary, after consultation with the Agency. Vertical sectioning of the sediment samples should provide an estimate of how deep into the sediment drilling waste is present at selected stations and whether a natural recovery process is underway.

Samples of sediments and the benthic fauna should be collected using an approved grab sampler. However, in some cases, a grab sampler may not be suitable:

- in areas where there are coral reefs or sponge communities;
- in areas where the seabed habitat is heterogeneous - a mixture of rock, stones and gravel with some soft-bottom areas;
- when monitoring discharges from the top-hole section after drilling; in such cases, there is so little dispersal that traditional sampling methods cannot convey the extent of the impacts;
- potentially at big depths (> 500 m)

In such areas, visual surveys using remotely operated or towed observation gear will be needed. Remotely operated vehicles (ROVs) are preferable because they provide more flexibility during a survey. In addition, visual surveys will be needed as a supplement to traditional methods of environmental monitoring in areas that are defined as vulnerable. In some places visual surveys may be needed to identify such areas.

The overall purpose of environmental monitoring is to describe whether and to what extent discharges from oil and gas activities have had impacts on a sampling station, a larger area around an installation, or a region. It is important that environmental monitoring results are used to verify the predictions and conclusions of the environmental impact assessments (EIAs) for individual fields and the region as a whole. The link between the EIA, actual discharges and environmental monitoring should be emphasized.

1.6 Quality assurance

The Agency wishes to stress the importance of quality assurance and control in connection with environmental monitoring. Quality assurance should be anchored with both consultant and oil company. The Agency considers the consultant's quality control as essential for the success of the environmental monitoring. The consultant's quality assurance system (QA-system) should be presented in the tender and in the final report, and operators must assess the quality of this system. In addition, operators should, if necessary, be able to discuss the QA-system with the Agency at the annual planning meetings.

The QA-system should include a verification of sampling, a plan for using reference samples, reviewing analytical methods and results and performing the quality control of the report. A standard QA-system should be used, for example ISO 9000 or OSPAR (2002-15). Quality assurance of the various analyses both in terms of type and frequency should be presented as part of the method description in the report. There is a minimum requirement that analyses are verified against reference samples run in the same test series as the real samples.

The QA-system should also be presented in the report. The results from the reference samples would be a natural part of result interpretation.

All suppliers of services for monitoring programs (analyses, fieldwork) must have ISO 17025 accreditation or an equivalent for the methods they use. The certification is to be awarded by Norwegian Accreditation or an equivalent foreign accreditation body. The Agency may give exemptions from this rule, depending on the type of analyses involved, if no official accreditation scheme is available in a particular area. This applies for example to new methodology for water column monitoring. Service suppliers must also document their own quality assurance and control routines.

2. Definitions and abbreviations

Background levels:

Concentrations of selected parameters (hydrocarbons, metals, radioactive substances) at the regional stations in each region, which are meant to provide levels as close as possible to the natural concentrations in the area.

Baseline survey:

The first environmental survey of an area or locality to obtain information on its chemical and biological status before a new activity starts.

Biological impact:

Found in an area if the fauna in a sample is significantly different from that at comparable regional stations in the same region. Calculations of biological impact are based on an overall evaluation of all the statistical analyses carried out on the biological material.

Chemical contamination:

Present in areas where the levels of the selected metals, radioactive substances and/or hydrocarbons are significantly higher than the expected background level (see the latter and LSC).

Diversity

Goal for species diversity in a benthic community, here as a function of the number of species and how specimens are distributed among these species. Described by diversity indices.

DP system (dynamic positioning system):

Computer-controlled system that automatically ensures the maintenance of the vessel's position, orientation, and possibly also speed. Positioning is done by using the vessel's own propulsion and positioning systems. Classified as DP1, DP2 or DP3 system according to IMO's standards for accuracy and redundancy (DP3 is the best, but DP1 is most often sufficient for visual surveys).

Drop-down camera:

Observation gear towed from a vessel and used to film the seafloor. Does not have the same flexibility in terms of positioning as an ROV has.

Grid:

A grid design is used to determine locations for the sampling stations if the position of the oil/gas field has not yet been established or if obstacles on the seabed make it impossible to use a radial transect design.

Grab sampler load:

One sediment load collected by a grab sampler.

HD video (High Definition video):

Video equipment that films using a higher image resolution than standard resolution. Requires use of fiber cable for real-time transmission from the ROV. The minimum resolution is 720p (*i.e.* 720 horizontal lines of video), while 1080p ("full HD resolution") is the most common format.

IMO:

International Maritime Organisation.

Installation:

All field development solutions for oil and gas production on the Norwegian continental shelf, including platforms, subsea structures, and floating production units.

JAMP (Joint Assessment and Monitoring Programme):

An international monitoring programme run by OSPAR, with joint guidelines for planning, implementation, analysis and reporting (now [MILKYS: Miljøgifter i norske kystområder](#)).

Juvenile:

Young, sexually immature specimens.

Kurtosis:

A measure of how peaked or flat the distribution of data is relative to a normal distribution. High kurtosis indicates that the data distribution has a narrower peak than expected for a normal distribution. Used in evaluating grain size distribution.

LSC (Limit of significant contamination)

A statistically calculated limit for chemical contamination, based on background levels from regional/ subregional stations.

Macrofauna

Organisms larger than 1 mm (*i.e.* that are retained on a 1 mm sieve).

Megafauna

Organisms larger than 20 cm.

Meiofauna

Organisms in the size range of 0.063-1 mm. Generally refers to specific groups of organisms (foraminifera, nematodes, harpacticoid copepods, etc.).

MOD-database (Environmental Monitoring Database):

A database containing data from the environmental monitoring programmes for the Norwegian continental shelf. It can be accessed at: <http://projects.dnv.com/MOD/Default.aspx?TOOL=HJEM>. Guidelines on how to import data in Norwegian can be found [here](#).

Monitoring of benthic habitats

Physical, chemical and biological investigation of the seabed.

Monitoring survey

A routine investigation of environmental conditions in a field or region conducted after production drilling has started.

Multivariate analyses

Statistical analyses that handle more than one variable in the same analysis and look for trends across several dimensions at once.

NPD

The sum of naphthalene, phenanthrene, dibenzothiophene and their C1-, C2- and C3 alkyl homologues.

PAHs (Polycyclic aromatic hydrocarbons)

All hydrocarbons in which the molecule contains two or more aromatic rings (see appendix I).

PCA (Principle Component Analysis)

A type of multivariate analysis where a set of variables is interpreted by a smaller set of underlying or latent variables that best explains the variation in the original set.

PICT (Pollution Induced Community Tolerance)

Method for measuring induced selection pressure on a community due to pollution.

Plankton

Organisms that spend all or part of their life cycle floating or drifting in the water and that have little or no independent mobility.

Radial transect

Preferred station design around an installation. It consists of two axes placed perpendicular to one another with the installation at the origin and the main axis in the prevailing direction of current flow.

Region

A delimited area of the continental shelf defined by geographical coordinates. The boundary towards the shore follows the coastal baseline.

ROV

Remotely Operated underwater Vehicle carrying a video camera, which can often be equipped with extra gear such as sonar, sensors, a manipulator arm and sampling equipment.

Satellites:

Installations producing towards a mother platform, mainly underwater structures.

THC

Total hydrocarbon content: content of all hydrocarbons in the material within a particular range of carbon chain lengths (n-C12 - n-C35), both those formed biologically and those originating from oil and other sources of pollution.

TOC

Total organic carbon (applies to sediment).

TN:

Abbreviation for total nitrogen in sediment.

Transect:

A continuous axis in the field-specific station network.

Transponder:

Equipment used in underwater acoustic navigation. Mounted on the ROV and communicates with transceiver / HIPAP system so that the position of the ROV can be displayed in a mapping software and logged.

UCM-fraction (Unresolved Complex Mixture)

Includes components in that fraction of the produced water that are not identified.

USBL system (Ultra Short Baseline):

Method for acoustic positioning most frequently used on offshore vessels where a transceiver mounted under the vessel communicates with a transponder mounted on ROVs.

Water column

The marine environment from the water surface to the surface of the sediment.

Water column monitoring

Mapping of pollutants or biological effects of pollutants, using caged or wild caught organisms in the water column.

3. Water column monitoring

Water column monitoring shall document whether and to what degree marine organisms in Norwegian waters are impacted by pollution generated by offshore petroleum activities. The monitoring should include oceanographic measurements, analysis of chemical parameters and investigations of both field transplanted organisms placed in cages and wild caught organisms.

3.1 Time frame

Programme

A program proposal for water column monitoring should be submitted to the Agency no later than February 1st the year the field survey is to be conducted. The final program must be sent to the Agency by April 1st of the same year. In the period between two filed surveys the annual planning meeting between the Agency, the Agency-appointed expert group, NOROG and relevant operators may be used as an opportunity to give an update on the status of working with development and qualification of new methodology.

Execution

Field surveys should be carried out outside the spawning period of relevant organisms (JAMP Guidelines for Monitoring Contaminants in Biota, 1999) and at a time when vertical density stratification is present. All fieldwork should be coordinated in time and place and should be conducted around the same period of the year every time so that results are comparable.

Reporting

A quality assured draft report from the field survey together with associated analysis results shall be submitted to the Agency by April 1st the following year after the survey was carried out. The Agency and the Agency's expert group will evaluate the report. Any potential comments to the report will be sent by June 15th. The comments from the evaluation must be answered. The deadline for delivering the final report is October 1st. The report will then be made available on the Agency's website before the "Forum for offshore environmental monitoring" takes place.

If results obtained during the surveys or sample processing deviate substantially from the expected status or trend, this must immediately be reported to the Agency.

3.2 Monitoring frequency and sampling design

Monitoring frequency

As a general rule, field surveys involving field transplanted and wild caught organisms are required at three-year intervals. Any modification in frequency must be justified and approved by the Agency.

There is still a need to develop methods for conducting water column monitoring. The period between two field surveys shall be used for further development and qualification of methodology. Monitoring results from previous surveys should as far as possible be used as a building block for further development and qualification of methodology.

Sampling area and design

Which areas are to be monitored must be selected in agreement with the Agency and relevant operators, and is to be described in the monitoring program together with the planned station network and sampling design. The area(s) are chosen based on knowledge regarding discharges and their dispersal and on the expected risk as a result of these discharges. Monitoring of the water column must look at relevant components in the discharges, including added chemicals.

The monitoring survey must include at least one suitable reference area both when using instrument rigs and when investigating wild caught organisms.

The positioning of the rigs equipped with monitoring instruments (among others passive samplers and caged organisms) in a particular area must be decided upon based on knowledge of the physical characteristics of the area and on dispersal models for relevant discharge components, including added chemicals.

The purpose of the monitoring is to give the best possible picture of the situation in the selected area(s), and deciding on the number and position of instrument rigs is an important contributing factor. The need to potentially change or expand the station network should be discussed in the report after each investigation/survey.

3.3 Organisms to be monitored

The monitoring program should describe which species are planned to be investigated. Sampling of wild caught organisms should be based on updated information on the occurrence, distribution and migration patterns of relevant fish stocks in the area.

Sampling of wild caught organisms should be representative of the most important naturally occurring species in the region(s). It is recommended to sample and analyze at least three different fish species. The availability of the different fish species will vary a great deal depending on location and season. Relevant species can be haddock, pollock, flatfish (dab or long rough dab), tusk and ling. The size of the fish should fit within a predefined size interval for both sexes. The predefined size will vary from species to species, but has to be specified in the monitoring program. At least 30 fish from each species and every area (reference and surveyed area(s)) should be collected. For further information regarding collection and choice of species, see OSPAR Agreement 1999-02 and 2008-09.

Based on experiences from previous years, it is recommended to place mussels in cages for monitoring of exposure and effects. *Mytilus edulis* should be the dominant species used, comprising at least 90 % of the specimens (there are three species of *Mytilus* in Norwegian coastal waters). Mussels from a sufficient number of stations (instrument rigs) should be analyzed per surveyed area. This may mean 15 stations or more, depending on the number of installations and the size of the surveyed area. The hydrocarbon and metal content in the mussels before placement in the field must be established by means of chemical analyses and must not be higher than background levels. The mussels must be acclimatized in clean water with the same temperature and salinity as the water in the area to be surveyed. In addition, the spawning condition of the mussels should be determined before placement in the field. Spawning mussels should be avoided. Selection of mussels for these purposes should otherwise follow guidelines given in OSPAR Agreement 1999-02.

3.4 Analytical parameters

The monitoring program should specify which analytical parameters are to be included. Which physical, chemical and biological parameters should as a minimum be analysed, is described below. Other parameters beyond these can be chosen based on knowledge regarding discharges and their dispersal as well as the expected risk related to the discharges. This includes discharge of added chemicals.

How long the organisms and the samplers should remain on site depends on which effect parameters are investigated. Some effect parameters can be expected to undergo changes throughout an exposure period.

Hydrographic parameters

The monitoring survey should include as a minimum the following hydrographical parameters:

- conductivity, temperature and density (CTD) with the purpose to establish vertical stratification, should be measured on a sufficient number of stations in order to provide a satisfactory description of temperature and salinity throughout the water column in the area. To be measured when placing and retrieving the cages.
- Current direction and speed from at least two stations close to each relevant platform, and not farther than 100 meters away from the platform
- temperature above and under all cages by means of logging sensors, to check that the vertical stratification and therefore the exposure is stable.

It should also be considered to include measurements of light by means of logging sensors, with the purpose to gather information about turbidity and hence to about food availability for the mussels.

Chemical parameters

The content of THC, PAH, NPD and AP in passive samplers should be investigated. The Agency can give exemptions if the operator can document that this is not suitable.

Passive samplers should be used to quantify exposure of caged organisms. They should be placed on all stations with caged organisms. Passive samplers should further be used to monitor dispersal of pollution/discharges to the environment and in order to validate dispersal models. Deployment of passive samplers for these purposes should include sampling at several stations and at several depths.

In addition, dispersal models and risk analyses should be used to decide whether it is necessary to include measurements of chemicals components in appropriate matrices (such as water samples or passive samplers).

Logging of aromatic hydrocarbons in the water column should also be conducted on a minimum of four stations by means of *in situ* fluorescence (two of the stations equipped with current meters).

Chemical analyses of the biological material are described in the following.

Parameters for biological material

The Agency expects that the monitoring includes as minimum analysis of the parameters provided in Table 3-1 for mussels and Table 3-2 for fish.

Chemical analyses are to be done using four composite samples from mussels at each station. Effect analyses are to be done on 15 mussel specimens from each station. As mentioned above, effects and metabolites should be investigated on 30 fish from each species and from each area, with the exception of DNA-adducts, which are to be analyzed on 15 female fish from each species and from each area.

Table 3-1: Parameters that are expected to be analyzed in mussels

| Parameter | Method | Type of tissue/matrix |
|--|--|-----------------------|
| Size | Soft tissue mass / volume of the mussel | |
| Spawning status | Histological | Gills / gonad |
| General health state | Filtration speed (clearance rate) and respiration or «stress on stress» ¹ | Whole mussel |
| PAH | GC-MS | Soft tissue |
| Metals (Hg, Pb, Cd, Ba) | ICP | Soft tissue |
| Chromosome damage | Micronucleus formation | Haemocytes |
| Lysosomal membrane stability (LMS) | Histological | Digestive gland |
| Acetylcholinesterase inhibition (AChE) | Enzymatic | Gills |

¹ See Martinez-Gomez, C. *et al.* 2012

Table 3-2: Parameters that are expected to be analyzed in fish

| Parameter | Method | Type of tissue /matrix |
|---|---|------------------------------|
| Size | Weight, length | |
| Gender | | |
| Liver somatic index (LSI) | Liver mass/body mass (without intestines and gonad) | |
| Gonad somatic index (GSI) | Gonad mass/body mass (without intestines and gonad) | |
| Condition index (CI) | Weight (without intestines and gonad)/length | |
| PAH/NPD | GC-MS | Filet |
| Concentration of PAH metabolites | GC-MS/LC-FD | Gills |
| Tissue changes, including lysosomal changes | Histology | Liver |
| DNA damage | DNA adducts | Liver |
| DNA damage | DNA strand breaks (comet) | Lymphocytes |
| Chromosome damage | Micronucleus formation | Red blood cells ¹ |

¹ See Baršienė, J. *et al.* 2013

In addition parameters given in Table 3-3 and 3-4 should be considered for mussels or fish. These methods may for example be used on a limited number of stations.

Table 3-3: Parameters to be considered for mussels

| Parameter | Method | Type of tissue /matrix |
|------------------------------------|-----------------------------------|------------------------|
| Lysosomal membrane stability (LMS) | Neutral red retention time (NRRT) | Haemocytes |
| Peroxisome proliferation | Acyl-CoA oxidase (AOX) | Digestive gland |
| Energy status | Cellular energy allocation (CEA) | Soft tissue |
| Gene expression level ¹ | qPCR | Gills |

¹ Related to oxidative stress, DNA repair, biotransformation, hormonal imbalance

Table 3-4: Parameters to be considered for fish

| Parameter | Method | Type of tissue /matrix |
|--|-----------------------------------|-----------------------------|
| Lysosomal membrane stability (LMS) | Neutral red retention time (NRRT) | Lymphocytes |
| ALA-D activity | Enzymatic | Red blood cells |
| Peroxisome proliferation | AOX, catalase activity | Liver |
| Oxidative stress (GR, GSH-PX, SOD, GSH/GSSG) | Enzymatic, concentration | Liver |
| Cytochrome P4501A activity | Enzymatic | Gill filaments ¹ |
| AChE activity | Enzymatic | Muscle |
| Gene expression level ² | qPCR | Gills, liver |
| Concentration of alkylphenol metabolites | GC-MS | Bile |

¹ Recommended because recent research has given indications of effects on gill filaments.

² Related to biotransformation, oxidative stress, DNA repair and hormonal imbalance (for example VTG).

NPD/PAH content in fish filet is analyzed out of food safety considerations. Even if levels above detection limits are rarely registered, such analyses should continue to be carried out in areas assumed to be most affected.

In addition, one should consider analyzing for relevant chemical components (on for example mussels) based on results from spreading analyses and risk assessments.

3.5 Sample collection and processing

Collection

Procedures for collection and processing of the sampled biological material are described in the *JAMP Guidelines for Monitoring Contaminants in Biota* (JAMP 1999-2), as well as in *JAMP Guidelines*

for *Contaminant-Specific Biological Effects* (OSPAR Agreement 2008-09). Any deviation from these procedures should be described in the monitoring program.

Other sampling procedures should be specified in the monitoring program.

Processing

Fish to be investigated must be kept alive until samples are taken for biochemical, physiological or histological analyses. Working surfaces used for sample processing must be clean, and the samples must be handled in such a way as to minimise the risk of sample contamination on board the vessel. The procedures followed should be documented and reported. For general procedures, see the JAMP 1999-2. Any deviation from these procedures should be described in the monitoring program.

Other sampling procedures should be specified in the monitoring program.

Sample storage

For general procedures, see the JAMP 1999-2. Any deviation from these procedures should be described in the monitoring program. Other sampling procedures should be specified in the monitoring program.

3.6 Analytical methods

The monitoring programme should include detailed descriptions of the analytical design, methods and reporting format- Quality assurance of the applied methods should be carried out, including by means of external intercalibration.

3.7 Further development of methods

The operators shall, as part of the environmental monitoring, contribute to developing new methods for monitoring the water column, cf. § 52 in the Activities Regulations. The field survey report should include suggestions for further methodological development for the periods between two field surveys, see chapter 3.8.1.

The following should as a minimum be carried out before new methodology is adopted in the field:

- An assessment of appropriateness and suitability of the methods being considered (including sensitivity and assessment of species differences)
- Adequate qualification under controlled laboratory conditions. For biological endpoints this will involve exposure to real or man-made produced water, specific components in the produced water, or to extracts of real produced water.
- A verification in field conditions. This can be done in relation to regular fieldwork carried out for monitoring purposes.

The Agency will give priority to qualifying methodology in the following areas:

- monitoring several levels of the ecosystem (for example phytoplankton, zooplankton, egg and larvae, fish from other trophic levels)
- improving monitoring of representative pelagic organisms
- gathering more information on effects by means of other endpoints/biomarkers for effect (transcriptomics, proteomics, benzo(a)pyrene hydroxylase (BPH), vitellogenin, epigenetic changes, YES/anti-YES/YAS/anti-YAS).

- gathering more information on pollution from added chemicals, both in terms of dispersal and effects
- gathering more information on potential sedimentation of components in produced water
- logging of hydrocarbon concentrations by means of fluorescence
- gathering information on potential effects of naphthenic acids
- gathering information on potential effects of the UCM-fraction.

Monitoring results should therefore be made available as soon as possible so that the period between two field surveys is used effectively.

3.8 Reporting

The purpose of offshore environmental monitoring is to provide an overview of the environmental status and of trends over time, seen in relation to offshore oil and gas activities. It is important therefore that the survey results are assessed taking into account the state of the marine environment as registered in previous investigations as well as the discharge history in the area. With this in mind, one should assess the condition of and potential impacts on the environment as part of the reporting process.

The report should be available in both Norwegian and English. The target group for the report includes oil and gas companies, environmental authorities, research institutions and consultancy firms. The survey and results must be presented in such a way that they also make sense for professionals who have not participated in the actual monitoring.

The report must provide a description of the extent to which organisms have accumulated hydrocarbons or any other petroleum-related substances. It should also indicate whether the organisms show signs of exposure and/or stress from discharges released in the area.

All unprocessed data and results should always be available to the authorities, preferably in a central database and in appendices to the report. Where all the data is stored and who is the contact person should be stated in the report.

The report should provide an overall interpretation of the monitoring results.

The biological responses should be presented not only as a function of distance to the source, but also as a function of the substances' concentration in the analyzed tissue, other exposure parameters and time integrated water concentrations estimated from the passive samplers. The report should also assess the importance of the biological response at several levels: for the individual, for the population and for the population in time and space.

The report is to be submitted electronically. Final reports from conducted field surveys/monitoring are published on www.miljodirektoratet.no once the Agency has approved them.

Unless otherwise specified, the Agency wishes to receive two paper copies of each report in addition.

3.8.1 Contents

The final scientific report should contain a complete documentation of the completed survey, focusing on:

- sampling design / field activities
- analytical parameters
- analytical methods and quality assurance
- results and conclusions of the survey
- main trends in the region or sampling area (if relevant)
- issues to be given priority in future monitoring

Summary

The summary should not exceed five pages. The target group includes the oil and gas companies, public administration and the general public.

A summary should include the following elements:

- brief description of the goals;
- description of the field work;
- presentation and discussion of the most important results (illustrated with figures and tables);
- main trends and comparison with any relevant earlier surveys;
- conclusions and recommendations.

Introduction

The following should be described for the region or area sampled:

- discharge history with concentrations of the different components in the discharge and other activities that may have affected chemical and biological conditions at the time of the survey;
- earlier surveys (table);
- goals and priorities for the survey in question.

Methods

The methods section should provide information about the following:

- reasons for the choice of sampling areas and sampling stations
- brief description of the completed field work, including the time frame for conducting the survey, number of stations/instrument rigs, sampling programme at each station or each sampling area and any deviations from the programme, with reasons (complete field log in the appendix);
- map with scale and depth contours showing the position of the stations and installations;
- brief description of the laboratory procedures for physical, chemical and biological analyses, including description of any deviations, with reasons, and an evaluation of whether/how results are affected;
- origin and condition of test organisms and handling before placement in test chambers, together with results from chemical analyses documenting background levels;
- principles for quality assurance routines in the field and in the lab, including any documented participation in intercalibration exercises for relevant methods;
- if relevant accreditation status and proof, together with documentation of control of results (chemical analyses) should be included in an appendix;
- description of chosen statistical methods including reasons for choosing them;
- information on where and how the processed material (samples, databases) is stored, and where the responsibility lies for the material and results and their availability.

Results and discussion

This chapter presents and discusses the results of the survey.

Results for each station or sampling area should as far as possible be presented in tables and figures. The observations and average results obtained for all the parameters analysed should be described. Other characteristics of the station or sampling area of significance for the discussion should also be presented.

If information is available, geographical trends, time trends and changes should be presented. The questions listed below should be discussed:

- Which responses can be detected?
- How do biological responses correspond with exposure parameters and with gradients in natural and anthropogenic environmental variables?
- How do the results relate to those of earlier surveys in the same area?
- How do the results relate to those of relevant surveys of nearby areas?
- Do the results reflect the discharge history in the area?

Overall evaluation and conclusions

This chapter should include final remarks on the environmental status and trends in the sample area and in the region.

Knowledge gaps and future development

Recommendations for the next survey should be made based on the results of the current survey.

The chapter should include a discussion on knowledge gaps connected to methods and analytical parameters that are used or should have been used for monitoring the water column.

Recommendations should be given regarding studies to be conducted or measures to be taken in the period until the next field survey, potentially as a part of the next field survey, with the purpose to further develop the monitoring methodology.

3.8.2 Appendices

The appendices should be delivered electronically and include as a minimum:

- the monitoring program decided upon in cooperation with the Agency
- complete field logs with date, time, position (GMS and UTM, which reference grid is used; grid zone must be specified), depth, number of samples and weather conditions presented in table format for each station or sampling area;
- analysis report including tables with analytical data.

4. Monitoring of benthic habitats (grab sampling surveys)

In soft bottom areas the surveys will consist of grab sampling of the seabed before exploration drilling on certain conditions (see chapter 4.2), before and during production drilling and production, and after decommissioning of the field. Sediment composition, chemical parameters and soft bottom fauna are to be investigated.

4.1 Time frame

Program

Deadlines for the submission of draft programmes for baseline surveys are established together with the Agency on a case-to-case basis.

Draft programmes for monitoring surveys of benthic habitats must be submitted to the authorities by 1st February of the year in which the surveys are to be carried out, see section 54 of the Activities Regulations. Final programs should be submitted to the Agency by 1st April and latest two weeks before field work starts.

Execution

Fieldwork in connection with monitoring of sediments and soft-bottom fauna should be carried out in the period 1st May-15th June in regions I-VIII (58-70° N). For regions IX-XI (North of 70° N) the period is extended until 1st July. The reason behind this is to avoid capture of juvenile stages.

In special cases, operators may carry out sampling at other times, but this must be well justified in the programme submitted to the authorities.

Reporting

The deadline for delivering verified draft reports from baseline surveys and regional monitoring surveys to the Agency is 1st April of the year after the surveys were carried out. The Agency and the Agency's expert group will evaluate the reports. Comments to the reports will be sent by 15th June. The evaluation comments must be answered. The deadline for delivering final reports is 1st October. The reports will then be made available on the Agency's website before the "Forum for offshore environmental monitoring" takes place.

If results obtained during the surveys or sample processing deviate substantially from the expected status or trend, this must immediately be reported to the Agency.

4.2 Survey frequency and sampling design

Baseline surveys

Baseline surveys are part of the benthic habitat monitoring and consist of taking samples of the seabed, describing the sediment composition, analysing the samples for heavy metals and oil compounds, as well as describing the composition and condition of the soft bottom fauna. In areas defined as vulnerable or where the presence of vulnerable species or habitats is probable visual surveys are required in addition to traditional monitoring (see chapter 5).

The scope of baseline surveys should be shaped by the need to obtain new knowledge.

The purpose of baseline surveys is to establish background data for the various parameters, as well as a 'robust' average value that will represent the basis for a local LSC (Limit of Significant Contamination).

Section 53 of the Activities Regulations requires baseline surveys to be carried out:

- before exploration drilling in new and previously unsurveyed areas (depending on existing knowledge about the characteristics of the seabed and the benthic fauna in the area);
- before exploration drilling in areas where vulnerable species and habitats have been shown to exist, or where their existence is probable;
- before production drilling.

Regional stations must be established as soon as possible and latest by the time production drilling starts.

A baseline survey is valid for six years, unless the Agency decides otherwise after consultation with relevant expert bodies.

Field-specific surveys

As a general rule, the same survey frequency is required for all types of fields and developments.

- Monitoring of a field starts with the first regional survey for the relevant region.
- After the first survey, field-specific monitoring surveys are as a general rule conducted every three years, as part of the regional monitoring surveys. Changes in the frequency of field-specific surveys must receive prior approval from the authorities.
- After the end of the production phase, two more field-specific surveys are required at three-year intervals. The possibility to add stations as close as possible to the installation's former position should be considered.
- The need for further monitoring of a field after this, is assessed by the competent authority.

The scope of field-specific surveys must reflect the results of previous surveys and the level of activity and discharges registered on the field in question. This means that certain stations or analyses may be omitted and new ones included in consultation with the Agency. The final

scope of these surveys is decided during annual planning meetings as described in chapter 1.4.

Regional surveys

The Norwegian continental shelf has been divided into eleven geographical regions for the regional monitoring of benthic habitats (see Figure 4.1). Table 4.1 provides further details on the location of each region, which fields are included in each region and the schedule for regional surveys. As a general rule, benthic habitats in each region should be surveyed every three years. A regional survey includes both the regional and the field-specific stations in the region.

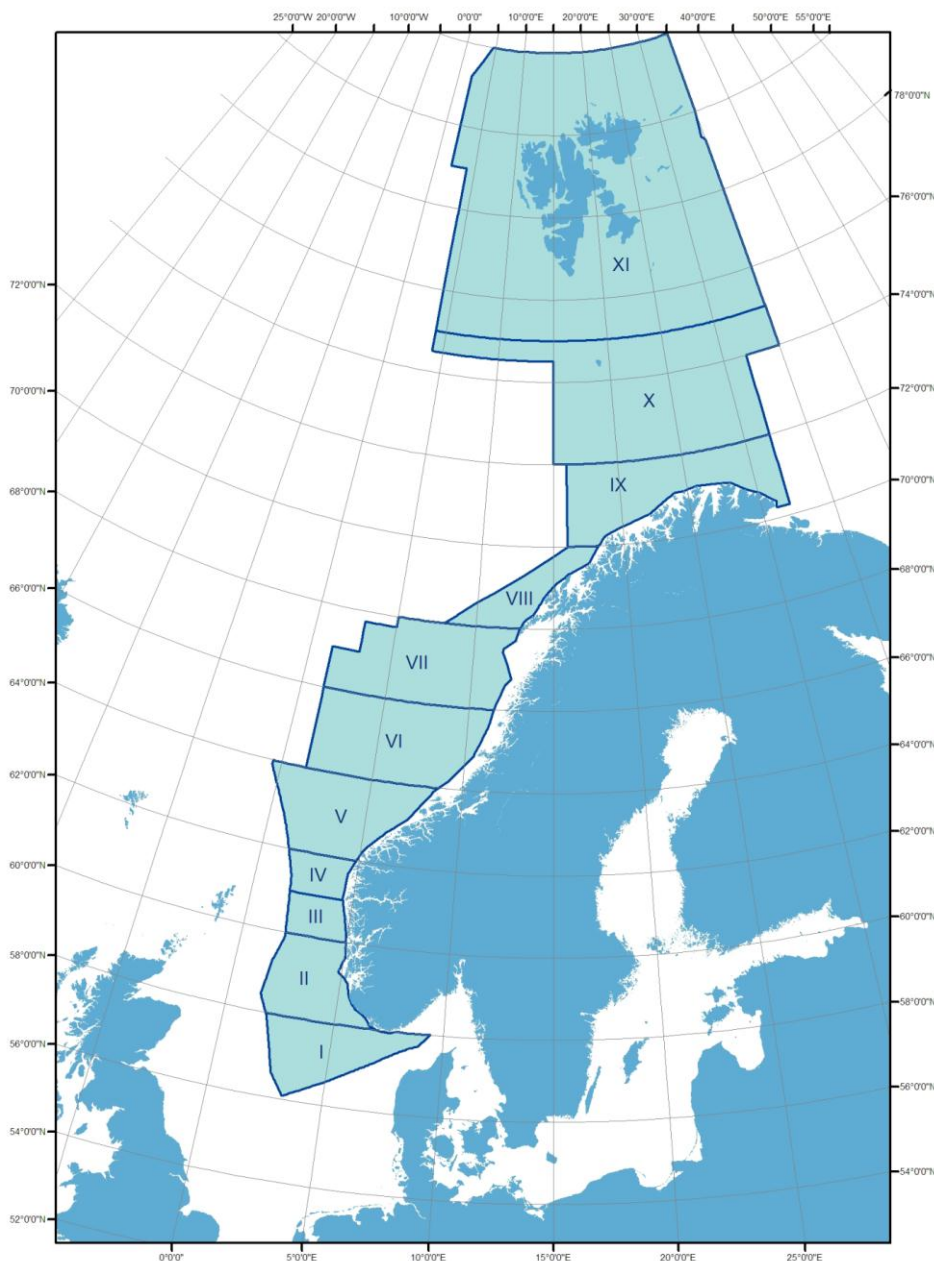

Figure 2-1. Overview of regions to be used for offshore environmental monitoring of benthic habitats

| Table 4-1 Monitoring of benthic habitats in the different regions in the period 2015-2017 | | | | |
|---|---|----------------------------------|------|------|
| Region/field | | Year for planned regional survey | | |
| North Sea | | | | |
| I | Ekofisk-area 56-58 °N <i>Ekofisk, Eldfisk, Embla, Tor, Valhall, Hod, Ula, Tambar, Tambar Øst, Gyda, Oselvar, Yme, Trym, and Brynhild, Bream²</i> | 2017 | | |
| II | Sleipner-area 58-60 °N <i>Sleipner Øst & Vest, Gungne, Glitne, Sigyn, Balder, Jotun, Grane, Alvheim, Heimdal, Skirne, Ringhorne Øst, Varg, Vale, Vilje, Volund, Volve, Gudrun, Atla, Gaupe, Bøyla, Rev, Edvard Grieg, Jette, Svalin and Gina Krog³</i> | | 2015 | |
| III | Oseberg-area 60-61 °N <i>Oseberg, Oseberg Sør & Øst, Brage, Tune, Troll, Fram, Fram H-Nord, Huldra, Vestefrikk, and Martin Linge</i> | | | 2016 |
| IV | Statfjord-area 61-62 °N <i>Statfjord, Statfjord Nord & Øst, Snorre, Tordis, Vigdis, Sygna, Kvitebjørn, Gullfaks, Gullfaks Sør, Gimle, Visund, Visund Sør, Gjøa, Vega, Knarr and Valemon</i> | 2017 | | |
| Norwegian Sea | | | | |
| V | Møre-area 62-64 °N <i>Ormen Lange</i> | | 2015 | |
| VI | Haltenbanken 64-66 °N <i>Alve, Njord, Draugen, Åsgard, Heidrun, Mikkel, Morvin, Kristin, Norne, Skarv, Urd, Tyrihans, Yttergryta, Marulk, Hyme and Skuld</i> | | 2015 | |
| VII | Nordland-area 66-68 °N | | | |
| VIII | Troms 68-70 °N | | | |
| Barents Sea | | | | |
| IX | Finnmark 70-72 °N <i>Snøhvit, Goliat</i> | | | 2016 |
| X | Barents Sea South 72-75 °N | | | 2016 |
| XI | Barents Sea North North of 75 °N | | | |

¹ In accordance with *Facts: the Norwegian Petroleum Sector 2014*, Norwegian Ministry of Petroleum and Energy.

² Expected to start production drilling in 2017

³ Expected to start production drilling in June 2015

4.3 Station network

The monitoring of benthic habitats has both a local and a regional focus. Within each region, the objective of field-specific monitoring is to reveal any impacts of individual installations on the surrounding area, while a set of regional stations is intended to reflect normal benthic conditions in the region and make it possible to detect whether oil and gas activities have more widespread impacts in the region. Previously established reference stations, where no impacts have yet been detected, must from now on be classified as regional stations. All changes in regional stations must be corrected in environmental monitoring database (MOD), as described in [Guidelines for importing data into MOD](#) (in Norwegian).

The locations of regional stations must be coordinated with the locations of the field-specific stations in the same region. The positioning of both types of stations must be based on information about:

- depth and topography;
- currents and dispersal patterns in the area in question;
- sediment characteristics and sedimentation patterns;
- discharge history of the fields;
- pipelines and other installations on the fields.

It is the operators' responsibility to make use of this information to revise a station network or establish a new one. Data on currents must cover a range of depths and the different seasons of the year. It is particularly important to obtain data for the depths immediately above the seabed as well as those where discharges are planned/ expected. Further elements to be considered when selecting either field-specific or regional stations are described below.

4.3.1 Selection of stations for baseline surveys

Regional stations

When a first regional survey is to be carried out, a representative selection of at least 10 regional stations should be established to provide a general picture of background benthic conditions in the region. The regional stations should therefore be located in areas that are not expected to be affected by discharges from the offshore oil and gas industry, either at the time or later. The Agency, in agreement with the Institute of Marine Research in Norway, considers that several of the stations used by MAREANO can be used as future regional stations. A new regional station must be established if a regional station proves to be affected by a later field development.

The following elements should be taken into consideration when positioning regional stations:

- they should cover all the main types of seabed (sand, clay, etc.), with main emphasis on sedimentation areas;
- if the water depth in the region varies, the stations should be located in such a way that typical depth intervals can be described;

- the stations should cover all parts of the region where there are field developments or where developments are expected.

When a baseline survey is carried out before production starts on a field, a minimum of three of the regional stations should be associated with the field in question. For a baseline survey carried out before an exploration drilling it may be enough to include only one regional station. These stations should be as representative as possible of background conditions on the field. They should be reasonably close to the oil or gas field in question and have similar sediment type and depth. If necessary, more regional stations can be established near the field/exploration drilling location area for this purpose. The same regional stations must be used from year to year both in the baseline survey and for later monitoring surveys of the field. Results from the regional stations are to be used as reference values for assessing possible effects observed at nearby field-specific stations

Field-specific stations

Field-specific stations for a baseline survey before production drilling should preferably be established using a radial transect design that is expected to be permanent for subsequent monitoring surveys of the field. The stations are to be placed at increasing distances from the discharge point (according to the geometric series 250 m, 500 m, 1000 m, 2000 m, etc). Transect length with increasing distance from the discharge point should be decided upon on a case-to-case basis. Stations less than 250 m from the installations should be established if practically possible and acceptable in terms of safety. If the final position of the oil or gas field centre has yet not been determined, a grid design may be used for station positioning across the field. A system with three parallel transects placed 1 km apart, with three to four stations in each transect is often used.

If the geographical characteristics of a field development indicate that a radial transect design will not be optimal, another design may be selected and used in subsequent monitoring surveys. The operator should inform on the reasons for doing this, and the station network should be done in agreement with the Agency. The stations should cover as much as possible of the entire area that will later be included in the monitoring programme. The orientation and surface of the station network should be determined based on the expected area of influence estimated with the help of prognoses on discharge quantities and dispersal modelling (using the same assumptions as the EIA carried out for the field).

The operator should be able to document the reasons for the selected station positioning, based for example on water current patterns, depth intervals etc. The stations should be located so that it is possible to determine the degree to which benthic habitats are affected by discharges from the oil or gas field. Each station must be given a unique designation consisting of a maximum of seven characters (including both letters and numbers). The same designation must be used on maps, in tables and in the text. If a station is later moved by more than 50 m, it must receive a new designation. Any such changes must be specified in the report and the station history must be shown in a table. These changes must also be recorded in MOD-database.

During a baseline survey before production drilling, samples should be taken from a minimum of three regional stations (including existing stations. These stations are expected to become the regional stations associated with the field in subsequent monitoring surveys.

It can be difficult to maintain a radial transect or grid design of the stations when carrying out baseline surveys in deep water (>500 metres). In such cases, the stations should be positioned as optimally as possible in relation to the discharge pattern, expected dispersal patterns and benthic conditions.

In connection with baseline surveys before exploration drilling one should follow the rule of establishing a radial transect if the drilling location is known, or a grid design if the drilling location is not known. The number of stations may depend on depth, seabed conditions and proximity to other fields / formerly investigated areas. The number of stations may often be reduced, but must be brought back to the standard number when conducting a baseline survey before production drilling.

4.3.2 Selection of stations for follow-up monitoring surveys

After drilling and discharges to the sea have started, the station network used for the first monitoring survey of a field should as a general rule be the same as that used for the baseline survey. However, depending on the overall monitoring activity in the region in question, certain stations may be omitted and new ones added in consultation with competent authorities. The monitoring programme should reflect the discharge pattern on the examined field. To make it possible to compare results between years, the positions of specific stations should not be changed. The deviation in position should not exceed ± 50 meters. If a station is later moved by more than 50 m, it must receive a new designation. Any such changes must be specified in the report and the station history must be shown in a table. These changes must also be recorded in MOD-database.

If it is difficult to collect representative samples at a station, for example due to high content of stones, sponge spicules or the like, the person responsible for the survey may decide to leave the station without taking samples. Any such deviations must be described in the monitoring report (see chapter 6.1 under methods). If necessary, authorities may also require the establishment of new stations in transitional zones between oil and gas fields.

Regional stations

As a general rule, a regional monitoring survey must include all the established regional stations. In new regions where there are few fields to be monitored, regional surveys may in special cases be limited to the regional stations that are associated with fields. A gradual reduction of the number of stations originally established as reference stations may also be considered in areas where fields are being closed down.

In the case of regional stations, all replicates of the chemical samples should be analyzed for calculating LSC. This should be done at least during three surveys (ca. 10 samples).

Field specific stations

When a final decision is made regarding the location of the installation(s) and discharge points, a permanent network of monitoring stations can be established using the baseline survey as a starting point.

In the case of single installations, a radial transect design should preferably be used, with one axis along the prevailing direction of current flow just above the seabed and the other perpendicular to this. This is the preferred design even in cases where a grid pattern was used for the baseline survey. In such cases, as many stations as possible from the grid should be retained. In the case of a complex field development (many subsea installations, for example) it may be necessary to deviate from this design, as stations must be located in a way that makes it possible to monitor the scale of the impacts of the installations. Most of the stations should be located downstream of the installations with respect to the prevailing current direction. One of the two radial transects should run North-South if no prevailing current direction can be identified.

Regardless of whether a grid or radial transect design is used, the station network should always include at least one station in each of the four main directions, even if there is no indication of chemical contamination or biological impact on the field. If the chemical contamination (for Ba 2xLSC is used as the limit) or biological impact on a field extends beyond the outermost stations in the network, new stations must be established outside these for the next monitoring survey. The new stations should be placed along the axes, at geometrically increasing distances. If later surveys (after the baseline survey and first follow-up monitoring survey) show elevated values for any of the parameters analysed at the first two stations downstream of the discharge point/installation, chemical analyses should as a minimum be carried out at all the innermost stations (along the other three radial transects) in addition to the three downstream stations. Analyses of THC and Ba (or the equivalent weighting agent) should be performed at all stations.

The scope of the monitoring surveys in each region and each field should reflect the level of activity, discharge history, and the results of the previous survey. As a general rule, the outermost stations sampled should always be unaffected (no biological impact or chemical contamination). If there is no measurable biological impact or chemical contamination, the station network can be reduced when the next benthic survey is carried out. For the same reason and provided discharges are low in the mean time, it may also be possible to extend the period between surveys of a field to six years.

4.4 Analytical parameters

This chapter describes what parameters or group of parameters should be analyzed in the collected sediment samples. Table 4.2 below provides an overview of requirements regarding numbers of samples, analytical parameters, sample storage, etc. The Agency may request analysis of additional parameters (screening of new substances) on the basis of information on discharges in a region or an individual field.

Table 4-2: Sediment samples, sample size and analyses

| Parameter | Sample depth | Baseline and first follow-up survey | Subsequent surveys | Sample storage and size |
|--|--|---|---|---|
| TOC/TN | 0-5 cm | Mixed sample from 3 grab samples for all stations | Mixed sample from 3 grab samples for stations where fauna is analyzed | ≤ -20 °C ¹ 100 g |
| Grain size | 0-5 cm | Mixed sample from 3 grab samples for all stations | Mixed sample from 3 grab samples for stations where fauna is analyzed | 300 g |
| THC | 0-1 cm 1-3 cm ² 3-6 cm ² | 3 samples 1 sample 1 sample | 3 samples 1 sample 1 sample | ≤ -20 °C ¹ 300 g |
| Drilling fluid | 0-1 cm | | | ≤ -20 °C ¹ 300 g |
| NPD and PAH | 0-1 cm | 1-2 samples | 1-2 samples | ≤ -20 °C ¹ 300 g |
| Metals -Ba ³ , Cd, Cr, Cu, Pb, Zn, Hg | 0-1 cm | 3 samples | 3 samples | ≤ -20 °C ¹ 50 g |
| Macrofauna | | 5 samples | 5 samples | 10 % formalin ⁴ Bengal red / Eosin |
| Meiofauna ⁵ | | | | |

¹ As stated in ISO 5667-19:2004 and ISO 16665:2013.

² Profile samples to be taken only on a selection of fields/stations.

³ And/or equivalent main component in the weighting agent (e.g. ilmenite contains titanium-iron, Ti).

⁴ Formalin may be replaced by less harmful stabilization liquids when testing of these is in place.

⁵ This can be relevant in areas where conventional sampling equipment cannot be used.

4.4.1 Sediment appearance on sampling

The characteristics of a sample should be described immediately after collection. Use procedure described in NS-EN ISO 16665:2013. See also *JAMP Guidelines for Monitoring Contaminants in Sediments* (OSPAR Agreement 2002-16). Such characteristics may include:

- the presence of drill cuttings, empty shells or other objects;
- the presence (or absence) of conspicuous fauna;
- smell (for example H₂S or oil);

- sediment description (sand, clay, gravel etc.) and stratification of layers;
- color (according to Munsells color charts for soils and sediment).

It is also recommended to log the number of unsuccessful grab loads.

4.4.2 Physical and chemical sediment analyses

Total organic carbon (TOC)/ total nitrogen (TN)

TOC is to be determined in samples from all stations in baseline surveys and first follow-up monitoring surveys. TOC should subsequently be determined in samples from stations where biological analyses are carried out. The same applies to TN-analyses, if these are included. The Agency may require continued analysis of TOC/TN if this is considered necessary.

Grain size distribution

Analysis of grain size distribution is required for all stations in baseline surveys and first follow-up monitoring surveys, and subsequently at stations where biological analyses are carried out. As a minimum, the percentages of silt/clay (<63 µm), sand (63-2000 µm) and gravel should be presented for all biological surveys as a supporting parameter for interpretation of soft-bottom fauna data.

Hydrocarbons and synthetic drilling fluids

As a general rule, analyses should include the groups of substances specified below. Certain analyses may be omitted if the operator can document that there have been no discharges of the substances in question. The operator should also take into account the discharge status on the field and in the region and assess whether other parameters should be analysed.

The following analyses should be done on samples collected from all stations in baseline surveys and first follow-up monitoring surveys:

- THC
- main components of synthetic drilling fluids (if used)
- NPD and PAHs (see appendix I).

Depending on the degree and extent of contamination, the analytical programme for field-specific stations can be reduced from the second monitoring survey onwards:

- THC (and possibly synthetic drilling fluids): all stations
- NPD and PAHs: all regional stations and as a minimum, the two downstream field-specific stations closest to the discharge point/installation. Also on stations
 - where significantly high values were found in the previous survey
 - where the concentration of THC (mean value of three grab samples, including olefins) is higher than 50 mg/kg
 - where biological impacts have been registered.

If significantly high values for THC or NPD/PAHs are found at the two closest downstream stations in one monitoring survey, NPD/PAH analysis should be reintroduced in the next survey for the three downstream stations and the inner stations around the installation in the three remaining directions.

Sediment samples from different soil layers (0-1, 1-3 and 3-6 cm) should be taken for THC analyses on a few fields. These may include fields where drilling with oil-based fluids was previously conducted, fields where leakages from injection wells were registered and fields where dredging operations have been carried out. Particularly which fields and what number of stations are to be investigated is determined after consulting with the Agency. Taking profile samples is not required when conducting baseline studies unless there are suspicions of past contamination from previously drilled exploration wells in the area.

Metals

For baseline and first follow-up monitoring survey, analyses of the following metals should be done for all stations: Ba or the equivalent main component in the weighting agent, Cd, Cr, Cu, Pb, Zn and Hg. Depending on the degree and extent of contamination, the analytical programme can be reduced from the second monitoring survey onwards. Metals should be analysed in samples from all regional stations and as a minimum in samples from the two downstream stations closest to the discharge point/installation. Metals should also be analysed in samples from stations:

- where significantly high values were found in the previous survey (2xLSC is used as the limit for Ba);
- where the concentration of THC (mean value of three grab samples, including olefins) is higher than 50 mg/kg;
- where biological impacts have been registered.

If significantly high values are found at the two closest downstream stations in one monitoring survey, all metals should be analysed in the next survey for the three downstream stations and the inner stations around the installation in the three remaining directions.

If the previous monitoring survey has not found elevated metal concentrations, these analyses can rest as long as no drilling activity was undertaken since, and there are no other relevant factors of importance for metal concentrations in the sediments.

4.4.3 Biologisk karakterisering

A thorough analysis of the soft-bottom macrofauna, including taxonomical identification and number of specimens belonging to each species should be carried out. The purpose of the investigation is to reveal potential impacts on the fauna as a result of discharges and contamination on the field. Calculations of biomass are not required.

In some cases it may be needed to investigate meiofauna in the sediment samples in addition to or instead of macrofauna. This may be relevant in areas where conventional sampling equipment cannot be used. Where such analyses are appropriate, the methodology and relevant fauna groups should be discussed with the Agency.

Samples for biological analyses are taken at all stations during baseline surveys and first follow-up regional surveys. In subsequent surveys, biological analyses should be included for the regional stations and the field-specific stations closest to each installation, preferably at a distance of 250 m. If biological impacts or values of THC > 50 mg/kg are found at field-specific stations, the minimum requirement for the subsequent survey is to take samples at

each station where a biological impact was found and the next station in the transect (further out from the installation).

4.5 Sample collection and processing

For sample collection and processing in the field (including requirements regarding the vessel, keeping field logs, choice of sampling equipment, collection procedures, etc.), please refer to NS-EN ISO 5667-19:2004 for sediments, NS-EN ISO 16665:2013 for soft-bottom fauna and NS-EN 16260:2012 for visual surveys.

If a laboratory is seeking approval of a new accredited method, the company should provide documentation that the results achieved with the new method are as good as or better than those achieved with the old method.

4.5.1 Sample collection

For baseline surveys of soft-bottom habitats, there should be chosen appropriate quantitative sampling equipment that can be used for the collection of both biological and chemical samples. The equipment must sample a minimum area of 0.1m². The use of a different type of sampling equipment in subsequent surveys requires approval from the Agency.

Benthic samples should be taken with suitable equipment to avoid sediment compression. The equipment used to subtract subsamples for metal and hydrocarbon/drilling fluid analysis should not contaminate the samples (see NS-EN ISO 5667-19:2004).

In shallow areas (<500 meters) one should as a rule use a modified van Veen grab (see Appendix II). Heavier equipment such as boxcorer can be used in deep areas (*e.g.* Ormen Lange). The most important is that the same type of equipment is used in subsequent surveys. If necessary or desirable, other types of equipment may be used after consultation with and approval from the Agency. In such cases, parallel use of both types of equipment during field work may be necessary on a temporary basis within a predetermined area. The purpose of such a trial is to determine whether there are differences in the results of significance for data interpretation and time trend analysis.

Separate samples should be taken from the upper 0-1 cm of the sediment (optionally from several depths) in each grab sample for analysis of metals and hydrocarbons/drilling fluid. Each sample is to be packaged, stored and analyzed separately.

Samples for chemical and biological analyses are to be taken from separate grab loads, collected in accordance with NS-EN ISO 16665:2013. This does however not exclude the use of modified van Veen grab sampler because chemical and biological samples taken with such devices are to be regarded as separate samples. For sieving of macrofauna samples in the field, see the same standard. Sieves should have round openings and a mesh opening of 1mm.

The samples collection methodology for meiofauna analyses needs to be discussed with the Agency. It is preferable to take separate core samples, but it is also possible to collect partial samples from the grab loads for such analyses.

4.5.2 Sample storage

Sediment samples to be analysed for grain size distribution, hydrocarbons, synthetic drilling fluids and metals are to be stored at a minimum temperature of -20 °C until they are analysed.

For preservation of biological samples in the field and sample storage, see NS-EN ISO 16665: 2013.

4.5.3 Establishment and storage of biological reference material

Accurate species identification is of fundamental importance for the reliability of the statistical analyses of the fauna. Experience has shown that quality control of species identification of the macrofauna needs to be improved. Consultants should insofar as possible use the same species identification literature.

One way of improving the situation is to build up a reference collection by retaining selected biological material from the surveys (specimens of genus and species). External taxonomists should validate the reference collection at regular intervals. It is important that the contractors/institutions carrying out the surveys use the services of the same external taxonomists. It is also important to be aware of the fact that reference collections and specimen samples from the surveys have different purposes and shall not include the same material.

It would be best to assign the responsibility for the storage and curation of the material to experts, for example within natural history museums. The Agency encourages oil companies/contractors to enter into agreements with suitable museums/institutions to ensure that the same procedures for sample selection, storage and curation are used in all surveys. Relevant museums are affiliated to the Universities of Bergen, Trondheim, Tromsø and eventually Bodø.

4.5.4 Analytical methods

One should use analytical methods described in updated Norwegian or international standards. All results of the chemical analyses of sediment are to be standardised using kg dry weight of sediment.

4.5.5 Physical and chemical sediment analysis

All stones larger than 5 mm should be removed from the subsamples before chemical analyses are performed.

TOC/TN

There is no Norwegian or international standard for analyzing TOC in sediments. Common to the methods in use today is the removal of inorganic carbon with acid and subsequent combustion. Detection is however different. We recommend that analysis of TOC is performed with instruments that have a hot wheel detector (HWD). In this way, TN can also be determined in the same batch, without significant additional costs.

Grain size distribution

The methodology for determining grain size distribution in the range 2000 to 63 µm is described in Bale & Kenny (2005). No further subdivision of the fraction < 63 µm is required.

The weight of each fraction is determined (to the nearest 0.01 g) and cumulative percentages by weight are calculated for each station. The results are further used to determine the median particle diameter and standard deviation, together with the skewness and kurtosis of the grain size distribution.

Hydrocarbon analyses

Hydrocarbons are to be determined in all samples from all stations, in accordance with Chapter 4.4.2. Methods with a high hydrocarbon extracting efficiency from sediment samples must be used. The analytical laboratory must be able to document this on request.

THC should be determined using a gas chromatography/flame ionisation detector (GC/FID) in the retention window C12 to C35. A reference oil sample will be used as an internal standard for the quantification. The reference oil in use is EDC 95/11¹. If this is replaced, intercalibration exercises using equivalent reference oils are required. NPD and PAHs should be determined by means of gas chromatography / mass spectroscopy (GC/MS), and results should be reported for both individual components, sum NPD and sum PAH. If the drilling fluid used contains organic components (ethers/esters), the samples must also be analysed for these substances.

Detection limits should meet the following minimum requirements:

- THC: 1 mg/kg dry sediment (the quantification limit to be given in the report);
- NPD/PAHs, individual components: 1 µg/kg dry sediment.

Assessment of development trends over time of THC concentrations and size of contaminated area should be carried out based on field-specific data. Similarly, analyses of development trends over time at the regional stations should be done. These analyses are to be carried out using a suitable statistical tool. Data sets from earlier surveys can be found in the MOD database.

Synthetic drilling fluids

The sediment samples are to be analyzed for the main component in synthetic drilling fluids. The analytical method needs to be adapted to the relevant substances. Where appropriate extraction and further processing of the sediment samples for these analyses may be conducted together with those for hydrocarbon analyses.

Metal analyses

The samples are to be analyzed after digestion with nitric acid, HNO₃. The following metals should be determined: Ba, Cd, Cr, Cu, Pb, Zn and Hg. If other weighting agent except Ba was used during drilling (e.g. Ti) the relevant parameter must also be analyzed. For determination of Hg, the samples should be freeze-dried or dried at 40 °C before sieving and digestion.

All parameters should be analyzed using ICP-MS or other well documented instrumental methods of high sensitivity that provide sufficient accuracy of the results. This needs to be documented in the laboratory's quality assurance system. Hg may be determined using cold vapor technique/Hg-analyzer. Detection limits for metals are shown in appendix III.

¹ HDF-200, previously used as a reference oil, is no longer being produced.

Analyses of development trends over time should be carried out for any metals with recorded values exceeding the background level. Metals with values below LSC may be left out in the illustrations included in the report.

Limits of significant contamination (LSC) and interpretation

LSCs are calculated based on the results recorded at regional stations. Before LSC values are calculated, a principal component analysis (PCA) of the chemical data should be carried out, both for the current year alone and for all available data (as a minimum data from the three last surveys in the regions). The results of the PCA will clarify whether it is necessary to split the region into subregions. If subregions are used, they must be the same for THC and for the weighting agent used (e.g. barite or ilmenite). LSC values are to be calculated both for the current year's data set alone and using the complete data set from all surveys in the region.

The values obtained with different calculation methods are compared and assessed to choose the relevant LSC (for the whole region or subregions).

LSC values are calculated from mean values, using a unilateral t-test and a significance level of 5 %. LSC values must contain a significant number of digits. The formula for calculating LSC values is given in the appendix IV.

As a general rule, the LSC values obtained on the basis of all available data are quite robust and vary only slightly from one survey to another.

4.5.6 Biological characterization

Special guidelines for the analysis of benthic fauna samples are given below. Otherwise, use EN ISO 16665: 2013 for species identification. As a general rule, taxonomic resolution should be at species level.

Organisms belonging to **Porifera**, meiofaunal groups such as the *Harpactoida*, planktonic organisms such as copepods and mysids, and fish may be identified and recorded if wished, but they should be excluded from calculations of community indices and from multivariate analyses.

For some groups (for example *Oligochaeta*, **Cnidaria**, **Solenogastres** and **Phoronida**), it may be necessary to operate with morphological forms only, since species identification requires special expertise and fixation techniques. This will fulfil the requirements for the subsequent numerical analyses. Solitary hydrozoans should be identified down to species level, but this is not necessary for colonial species. As an exception, larger species of *Foraminifera* may be identified. Statistical analyses are to be performed both with and without such species

The taxonomic resolution should as a minimum be the same in the follow-up monitoring surveys as in the baseline survey.

Newly settled juveniles of benthic species should be identified and included in the data set, with the exception of newly settled larva of *Echinoidea*. If juveniles appear among the ten most abundant organisms in the data set, the statistical analyses should be performed both with and without these in order to illustrate their influence on the benthic community.

Only professionally qualified personnel should perform species identification. Documentation of quality control procedures, as well as species identification literature should be available on request. Taxonomic identification should be done using up to date, authoritative literature and digital identification tools. As a general rule, taxonomic resolution should be at species level.

Databases like Worms ([World Register of Marine Species](#)) or ERMS ([European Register of Marine Species](#)) should be used to provide consistency in terms of species identification so that data is comparable.

4.5.7 Processing of biological data

The following data is required for each station:

- complete lists of recorded species (species name and number of specimens of each species);
- total number of species;
- total number of specimens standardized to a sediment surface area of 0.5 m²;
- table with the ten most abundant species (species name, number of specimens and percentage from the total number of specimens at the station), also showing the total number of species found at the station;
- H' (species diversity as Shannon Wiener index on a log₂ base);
- ES₁₀₀ (expected number of species per 100 individuals)
- NSI
- ISI
- NQ11

H' and ES₁₀₀ are indexes for species diversity. NSI and ISI are sensitivity indexes recently updated and adapted to Norwegian soft bottom fauna (Rygg og Norling 2013). They describe the extent to which the soft bottom community consists of tolerant or sensitive species. NQ11 is an index that provides an overall indication of species diversity and sensitivity. It is based on the AMBI index for faunal disturbance (Borja *et al.* 2000) and the number of species and individuals in a sample.

All the results above should be standardized to a sediment surface area of 0.5 m².

The following analyses should be done at all stations on a field, including the regional stations associated with the field, and in addition for all the regional stations as a group:

- cluster analyses based on the Bray-Curtis dissimilarity index (Bray & Curtis 1957), followed by Group Average Sorting;
- ordination by non-metric multidimensional scaling (MDS).

The multivariate analyses should be carried out based on the values obtained by summing up the five samples from each station. Multivariate analyses should also be used to investigate the correlation between chemical and biological parameters. It is important that the results are presented and interpreted in a satisfactory manner, given the aim of the survey. The method used to identify stations with disturbed fauna should be described in the report's chapter on method description, as do the reasons for choosing it.

Other analytical methods than those specified above may also be used, provided that they come in addition to those listed above.

4.5.8 Estimation of affected area

A conservative estimate of the maximum area with THC-contaminated sediment (as defined by LSC) is required. In addition, the maximum area with THC over 50 mg/kg² and the area with disturbed bottom fauna are to be estimated. The calculations are based on the assumption that affected areas are elliptical, and that the entire area within the innermost unaffected stations is considered contaminated. The calculation method is described in appendix V. The calculated surface should be compared with those of previous surveys. This can be done provided that information is given on which wells and installations are used in the calculations, for example in a table. If stations are omitted from a survey, resulting in the impossibility to calculate the affected area, it is assumed that the results of the previous year's survey are still valid.

4.6 Reporting

The purpose of offshore environmental monitoring is to provide an overview of the environmental status and of trends over time seen in relation to offshore oil and gas activities. It is important therefore that the survey results are assessed taking into account the state of the marine environment as registered in previous investigations as well as the discharge history in the area. With this in mind, one should assess the condition of and potential impacts on the environment as part of the reporting process.

The results are to be presented in a technical report and a summary report with authorities and the general public as the main target groups. A more detailed description of the expected report design follows below.

The report is to be delivered in electronic format. Unless otherwise specified, two printed copies of each report should be sent to the Agency in addition.

Final reports from conducted monitoring surveys are made available on www.miljodirektoratet.no after approval from the Agency.

The Agency expects one report for each regional survey. The report should provide an overview of the main environmental trends in the region and on the individual fields investigated. All raw data and results derived from these should be available to the authorities at all times in the centrally established MOD database and in the form of electronic appendices to the reports. Consistency between the database and the reports, for instance in terms of results, variables and station names is very important. In order to reduce the risk for errors and omissions in the database, data should be imported in the MOD database after the reports are quality assured and approved. This will contribute to the quality assurance of data in the database. It should be stated in the report where the collection of the data for all fields and regions is stored, as well as who is the responsible contact person.

² Commonly used lower limit for impact on benthic fauna due to chronic exposure.

Two separate reports from the monitoring surveys should be delivered: a summary report in English and Norwegian, and one main report in Norwegian. The raw data files, including the cruise log, must be provided as appendices to the reports.

4.6.1 Summary report

The summary report should be maximum 20 pages long, and be delivered in both Norwegian and English. The target group for the report includes the oil and gas companies, environmental authorities, and the general public.

The summary report should include the following elements:

- A one-page summary with a brief goal description, with tables or figures showing environmental status and trends in the region
- a brief description of the field work
- presentation and discussion of the most important results (illustrated with figures and tables);
- main trends and comparison with earlier surveys, as well as uncertainty aspects connected to that
- illustrations of seabed areas where contaminated sediments and biological impacts have been found should be included for each field and for the region as a whole
- conclusions and recommendations.

4.6.2 Main report

The target group for the report includes oil and gas companies, environmental authorities, research institutions and consultancy firms. The survey and results must be presented in such a way that they also make sense for professionals who have not participated in the actual monitoring. The final scientific report should contain a complete documentation of the completed monitoring survey, focusing on:

- analytical parameters
- analytical methods and quality assurance
- the results and conclusions of the survey;
- trends within individual fields and the region as a whole;
- issues that should be given priority in future surveys.

The main report should include the elements described in the following.

Summary

A brief description (no longer than one page) of the survey, similar to that in the summary report.

Introduction

The following should be described for each field and, if relevant, for the region as a whole:

- the area expected to be affected by discharges from oil and gas activities, according to the EIA

- drilling and discharge history and other activities that may have affected chemical and biological conditions up to the time of the survey
- earlier surveys (table)
- main trends in pollution levels up to the moment of the current survey
- specific goals and priorities for the current survey.

Methods

The methods section should include the following:

- map of stations showing coordinates, map scale, depth contours, existing installations;
- reasons for the choice of stations (if any changes from earlier surveys);
- table with overview over station changes;
- brief description of the completed field work, including time frame for conducting the survey, number of stations, positioning system, sampling programme at each station and any problems or deviations from the programme and these guidelines, with reasons (complete field log in appendix);
- the report should mention whether sampling was not performed at a station or whether samples were rejected due to high stone or sponge spicule content in the sediment. Include a discussion on whether and /or how results were affected.
- brief description of the laboratory procedures (physical, chemical and biological analyses): description of any deviations, with reasons, and an evaluation of how they affect the results;
- detection limits, quantification limits and LSC must be reported for chemical analytical methods;
- principles for quality assurance routines in the field and laboratory, including details on participation in intercalibration exercises for relevant methods
- accreditation status and proof, together with documentation of quality control of the results (chemical analyses) should be included in an appendix;
- which formulae for indices and which statistical methods were used, etc.;
- procedure and criteria for identifying stations with disturbed fauna;
- information about any supplementary analyses and reasons for conducting them;
- where and how the processed material (samples, reference collections, databases) is stored, responsibility for the material and results and their availability.

Results and discussion

This chapter presents and discusses the results of the survey. The elements to be included are summed up in Table 4-3 and discussed below.

Table 4-3: Physical/chemical and biological parameters that should be included in report

| Physical/chemical characterization | Biological characterization |
|--|--|
| <ul style="list-style-type: none"> • grain size distribution divided as a minimum in silt/clay (< 63µm), sand (63-2000µm) og grus, | <ul style="list-style-type: none"> • number of species and specimens standardized to a sediment surface area of 0.5 m² sediment (per station) • community indices (H', ES₁₀₀, NSI, ISI NQ1), |

Table 4-3: Physical/chemical and biological parameters that should be included in report

| Physical/chemical characterization | Biological characterization |
|--|--|
| <ul style="list-style-type: none"> • for grain size, median particle diameter and standard deviation should be provided, • color smell appearance, • total organic carbon (TOC), total nitrogen (TN) - voluntary, • table with average value of all parallel samples as well as standard deviations of chemical results from all previous surveys • graphs showing relevant chemical data against year, presented with mean values (any high standard deviations to be marked with * and commented upon in the text), <ul style="list-style-type: none"> • LSC calculated based on results from regional stations for the current year's data set alone and for the entire data set (at least the three last surveys) i order of priority, for one of the following: <ul style="list-style-type: none"> - the whole region (all regional stations) - subregions if used (based on selected regional stations) - a selection of regional stations associated with each field in the region, • concentrations that are significantly different from background levels, • THC-contaminated areas for the fields and the region (both significantly over background level and over 50 mg/kg). | <ul style="list-style-type: none"> • the 10 dominant species with density and percentage of total, • similarity between stations, grouping by means of multivariate analyses, • geographical distribution of station groups; • description of station groups based on: <ul style="list-style-type: none"> - depth - sediment characteristics - content of organic matter - content of hydrocarbons - content of metals - biological parameters, • analysis of correlation between community indices, density of selected species, physical properties of the sediment, and hydrocarbon and metal content (the significant correlations should be further analyzed to identify potential cause-effect relationships), • area with recorded faunal disturbance. |

Similarities and differences in terms of chemical condition and faunal structure between field-specific and regional stations should be scientifically assessed on the basis of the biological results and multivariate analyzes. It is important that the results from the reference samples and the uncertainty estimations are taken into account in the discussion. This provides important information about the extent to which trends can be identified or whether identified changes are within acceptable uncertainty limits for the methods used.

Description of individual stations

Tables and figures should so far as possible be used to present the observations and the average results obtained for all physical, chemical and biological parameters and all indices required. Any classification of these should be explained and reasons for its use given. Other characteristics of the station that are of significance for the discussion should also be presented. All relevant information given in figures and tables should also be mentioned in the discussion. The same results should however not be illustrated in both tables and figures.

Description of individual fields

- mean values, range (min.-max. and SD or SE), geographical gradients of concentrations, and biological indices across the field;
- comparison with corresponding characteristics for the associated regional stations
- results of multivariate analyses on the similarity between groups of stations (Clarke et al. 2008)
- to what degree the physical/chemical characteristics could explain the observed biological pattern
- specification of the areas where chemical contamination and biological impacts have been recorded
- trends over time on the individual field for the characteristics listed in the bullet points above.

Description of the region

- mean values, range (min.-max. and SD or SE), geographical gradients of concentrations, and biological indices across all regional stations;
- results of multivariate analyses on the similarity between groups of stations, installations, etc.;
- to what degree the physical/chemical characteristics could explain the observed biological pattern;
- specification of the total areas in the region where chemical contamination and biological impacts have been recorded;
- changes in any of the points above since the previous survey.

The points listed in Table 4.3 should be included in the results and discussion chapter. They should also provide the starting point for answering the questions listed below.

- Can one group stations across the field or in the region based on a geographical or other pattern?
- How far from the discharge point/installation are chemical contamination (above LSC) and biological impacts statistically detectable?
- How big is the area with measured THC-concentrations above 50 mg/kg?
- How do the responses correspond with gradients in natural and anthropogenic environmental variables?
- How do the results correspond with those of earlier surveys?
- How do the results correspond with those of relevant surveys in nearby areas?
- Are the effects correlated with the discharge history of the field or region?

The extent of the area with chemically contaminated sediments and the area with disturbed fauna should be illustrated both in tables (km² for chemical contamination and biological disturbance) and in maps for the field/region in question.

Overall evaluation and conclusions

This chapter should contain concluding remarks on the environmental status and trends on individual fields and in the region, discussed in relation to EIA predictions and results of previous surveys. The most important trends regarding the benthic habitat both on individual fields and in the region should be described. The chapter must also identify areas where there are particular problems.

If visual surveys were carried around the same time as the benthic habitat survey or relatively recently, the results of these should to be taken into account in the evaluation and interpretation of the survey results.

Recommendations

The report should include thoughts on future environmental monitoring based on this year's work:

- suggestions for future surveys based on current results.
- suggestions for improvement, modernization and rationalization of the monitoring methodology.

4.6.3 Appendices

The appendices to the report should be delivered electronically and should as a minimum include the following:

- final program for the surveys as established together with the Agency
- complete field logs: date, time, position (GMS and UTM, which reference grid is used; grid zone must be specified), depth, number of grab samples and weather conditions presented in table format for each station;
- analysis report;
- tables of all analytical data ;
- raw data files in Excel format.

5. Monitoring of benthic habitats (visual surveys)

In areas with hard substrate, where conventional sampling equipment cannot be used, or in areas where there is reason to believe vulnerable species and habitats may occur, customized surveys shall be performed as a replacement or supplement to grab sampling surveys.

Examples of such habitats found on the Norwegian continental shelf may be:

- Sponge communities (Deep Water Sponge Aggregations, OSPAR 2010a)
- Sea-pen and burrowing megafauna communities (OSPAR 2010b)
- Corals (Norwegian Red Lists for Species and Habitats)
- Established spawning areas (for example sand eel or other species)

Visual or acoustic methods, or a combination of the two, may be used for this purpose. These surveys are to be carried out primarily before exploration or production drilling or in connection with field decommissioning.

The Agency may if needed request that such surveys are performed during the production period as well. Visual surveys have been performed in the Norwegian Sea and the Barents Sea, while visual monitoring (*i.e.* revisiting a site) will be carried out for the first time as part of the regular monitoring to be performed in 2015. The methodology for carrying out visual monitoring is still under development.

A European standard for visual surveys using remotely operated and/or towed observation gear for collection of environmental data (EN 16260: 2012) has been developed. The standard provides guidance for carrying out visual surveys of the seabed and the benthic fauna in connection with petroleum activities when it comes to positioning accuracy, maximum speed of mapping, personnel requirements and the like. For recommended procedures for storage and quality assurance, see the same standard.

5.1 Time frame

Deadlines for planning and reporting as described in chapter 4.1, are also valid for visual surveys. The time limitations mentioned in the same chapter, under execution, do not apply for visual surveys.

5.2 Recommended equipment

The following equipment is necessary to carry out visual surveys:

- Suitable survey vessel with dynamic positioning system (DP system)
- ROV suitable for the purpose (see below)
- Underwater navigation system/ USBL system
- Data communication (fiber optic connection between the bottom and the surface)

- High resolution video (preferably HD)
- Camera for still images
- Lasers to measure dimensions

Towed observation gear such as drop-down cameras may alternatively be used, although that is generally not recommended. A drop-down camera is not suitable for mapping previously identified targets such as potential coral reefs, pockmarks or crustal areas. A drop-down camera may be an alternative to carry out linear transects for investigating sponge communities (the system must have wave compensation and a good enough light source).

Depending on the survey type there will be different requirements connected to for example the observation gear or the accuracy of the underwater positioning system. More detailed recommendations regarding necessary equipment can be found in appendix V. The standard NS-EN 16260:2012 should be observed.

5.3 Survey strategy and choice of survey lines

Visual surveys on the Norwegian continental shelf are carried out within the eleven geographical regions that are established for the regional monitoring of benthic habitats. The location of each region, which fields are included in each region, and the schedule for regional surveys are given in Table 4.1 (chapter 4.2).

Visual surveys are carried out using a remotely operated underwater vehicle (ROV) or towed observation gear. Survey lines should be representative of the investigated area. The scope of the surveys and the density of survey lines will vary depending on the activity to be undertaken, how heterogeneous the seabed in the area is considered to be, the dominant fauna communities and to what degree vulnerable habitats are present in the area.

The operator should in all cases consider conducting detailed surveys as described in section 5.3.3. Surveys described in section 5.3.1 and 5.3.2 may however be sufficient in some cases. No matter how detailed survey is planned to be, the main purpose is to cover the gradients of environmental factors (e.g. depth and sediment type) expected in the investigated area. The goal is to be able to identify any existing vulnerable habitats and species.

If anchoring of the drilling rig is planned, the potential anchor corridors should also be investigated. Transects investigated in the baseline survey should where possible be used in any subsequent monitoring.

5.3.1 Surveys where the spud location is not known

Background data, such as bathymetry and sonar data, if available, should be used when planning the survey design. If background data is not available, standard line surveys with a recommended density of two kilometers per km² survey area should be performed. Examples of survey designs are shown in Figure 5-1

Survey lines should be planned so that both central and outer parts of the field in all geographical directions are examined. The survey lines should as far as possible be placed so that they go by any field-specific stations used for sediment monitoring.

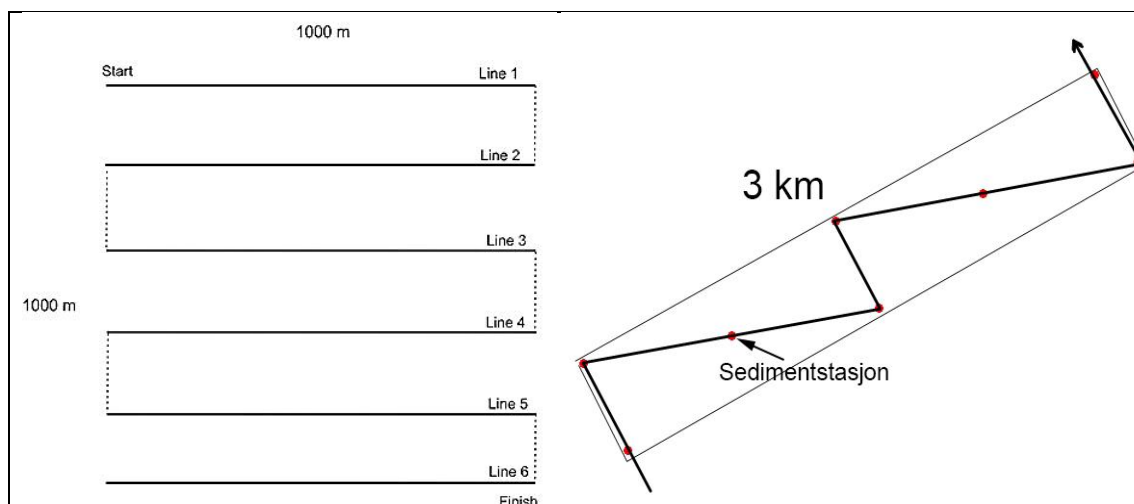

Figure 5-2 Examples of survey designs covering a larger area where the spud location(s) is/are not known. The number and length of the survey lines should be adjusted depending on the size of the area to be mapped.

Where there is one or more potential drilling locations and the final spud location is not clearly defined, it may be appropriate to use a polygon-shaped survey design (survey areas defined by four outer points). At least three survey lines should cross each of the polygons.

5.3.2 Surveys where the spud location is known

If the spud location is known, the aim of the survey should be to cover the near-by area in order to detect any potential impact from the activity. The center point should at a minimum be crossed twice. Figure 5-2 shows examples of survey designs.

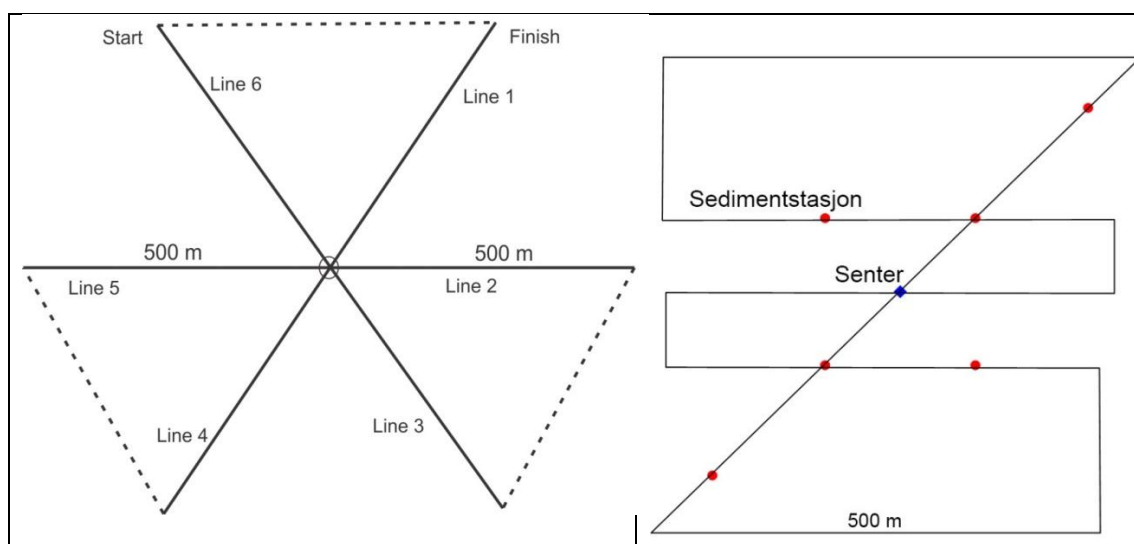

Figure 5-3. Example of survey design covering a larger area where the spud location is known. The number and length of the survey lines should be adjusted depending on the size of the area to be mapped.

5.3.3 Detailed surveys

Detailed surveys with relatively dense survey lines may be necessary in areas where one expects greater densities of vulnerable species and habitats. The size of the area to be surveyed will vary depending on whether the spud location is established or not, among other things.

The survey lines should be parallel and cover the entire area that is expected to be affected by the planned activity and a sufficiently large outer area in order to be able to describe impacts compared to natural conditions. The distance between the survey lines may be adjusted according to the survey purpose and accuracy requirements, as well as a cost-benefit assessment. An example with 25 m equidistant survey lines is shown in Figure 5-3.

Collected data may then be used for density interpolations of the surveyed communities within the mapped area. Extrapolation (of for example sponge amounts) outside the mapped area is not recommended.

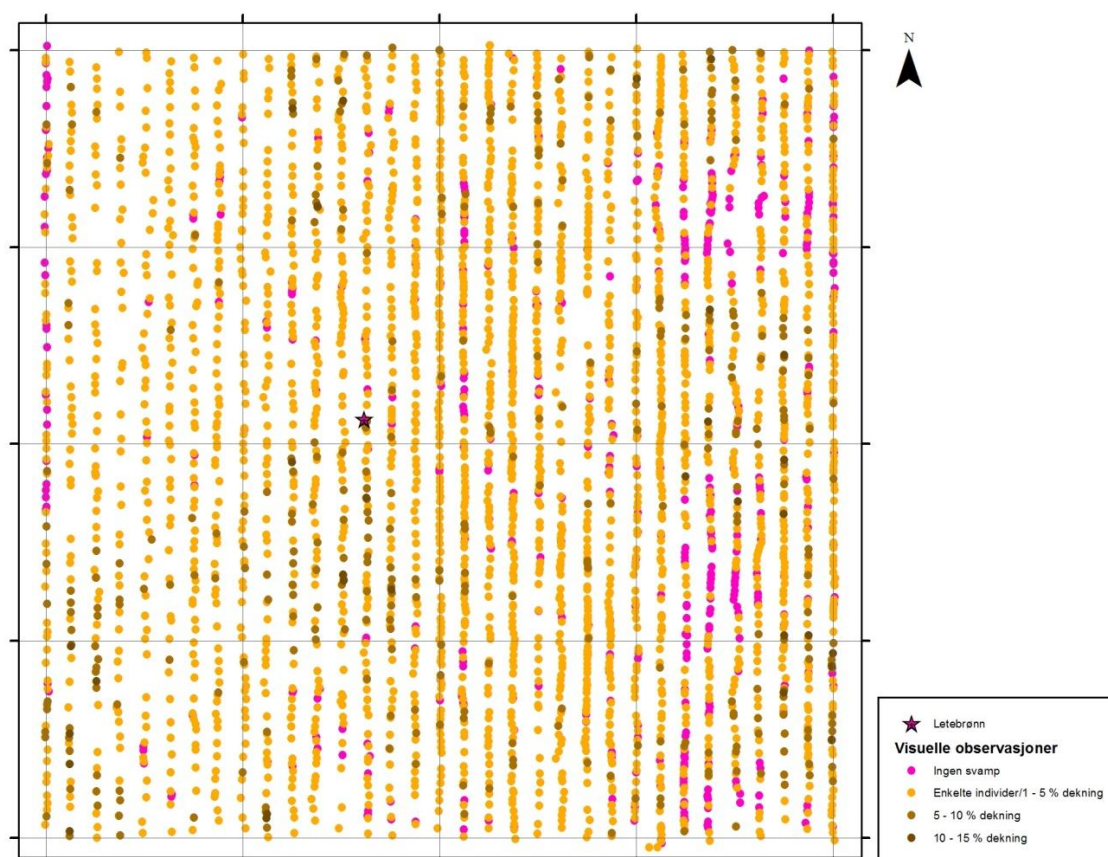

Figur 5-4. Example of detailed survey design with 25 m equidistant survey lines.

5.4 Survey methodology for different fauna groups

5.4.1 Corals

Investigating coral presence requires that areas that may potentially contain such structures are already identified using acoustic methods. From the operators' site survey that is

performed on each field, one can identify areas with cold water coral reefs or stone formations and other coral species that do not form reefs. These areas should be classified as potential coral areas and examined visually.

5.4.2 Sponge communities

Sponge communities should be filmed continuously along the survey lines. Still images should be taken every 30 m as a minimum (even every 20 m) and used to quality check the quantitative estimations. If still images alone are used to obtain the quantitative estimations it is important that the images are not taken too close to the seabed. Multiple images should preferably be used to come up with average quantity estimations for a given area. Sponge communities being mapped should as a minimum be divided into the following groups:

- «**Soft bottom sponge communities**»: Bulky sponges growing directly on the seabed. Includes several species, especially *Geodia baretta* (kålrabisvamp in Norwegian) (*Geodia* spp., *Aplysilla sulphurea*, *Stryphnus ponderosus* and *Steletta* sp.). These are typical species for the OSPAR-habitat «Deepsea Sponge Aggregations» (OSPAR 2010a).
- «**Hard-bottom sponge communities**»: Sessile sponges growing on rocks and other hard substrate (especially *Phakellia* spp., *Axinella infundibulum*, and *Antho dichotoma*). It is common to find sponges on hard substrate. When the sponge density is high, these areas will also be ecologically important.
- «**Glass sponge populations**»: Hexactinellida. May occur in higher densities especially in deeper waters.

Depending on the purpose of the survey, it may be a plus to distinguish between different species within the main groups. Some sponge species, such as *Asconema* sp., may occur both on hard substrate and in larger amounts together with or on soft bottom sponges. If large quantities are observed, it is recommended to map this specifically.

For mapping carried out in connection with petroleum activities, where it is often needed to investigate sponge distribution over larger areas, it is recommended that the coverage degree of the various sponge categories along the survey lines are as a minimum classified using the following criteria:

- <1 % of the seabed is covered (no sponge/single specimens)
- 1-5 % of the seabed is covered (scattered)
- 5-10 % of the seabed is covered (common)
- >10 % of the seabed is covered (high density)

The total area of seabed classified in the different groups should be summarized and presented in easily understandable figures. Figure 5-4 is an example of how survey data from a sponge community survey is presented.

In the Barents Sea, experience shows it is unlikely to find sponge communities covering more than 10-20 % of the seabed. The classification can be divided into several categories, or individuals and size groups can be counted if that is helpful with regard to the purpose of the survey. The results must still be comparable with other surveys in the Barents Sea, and this can most easily be achieved by specifying the coverage percentage.

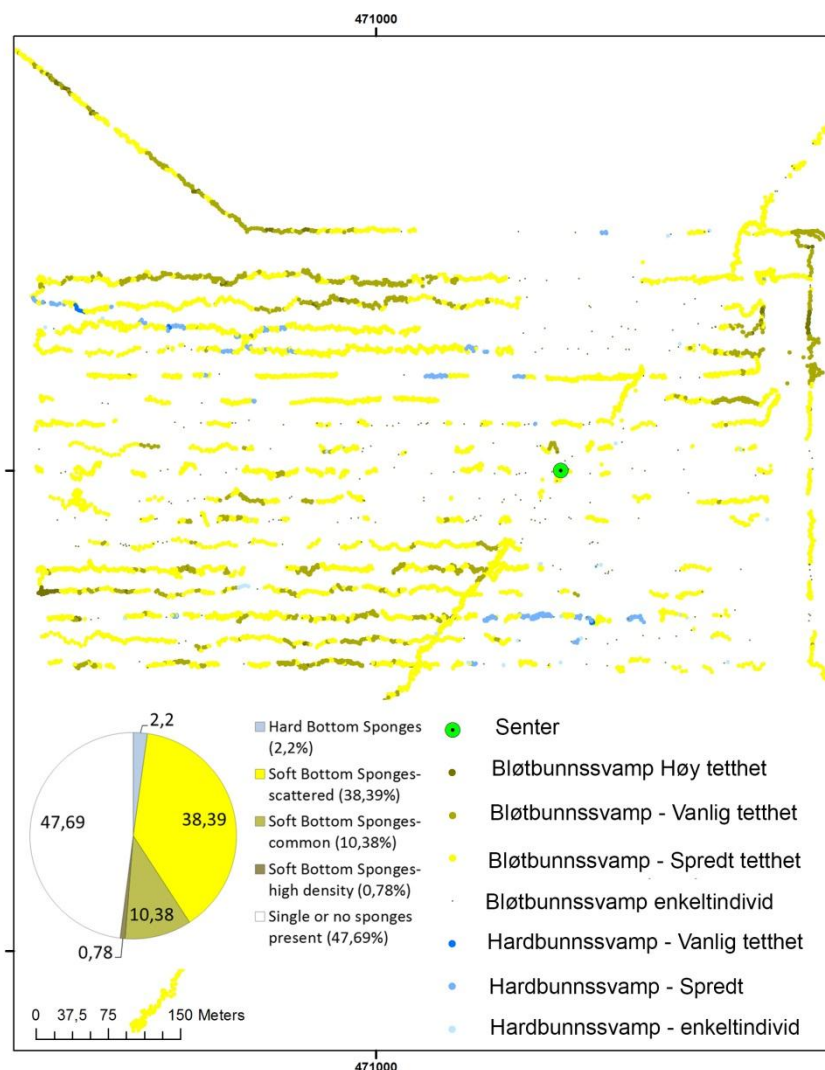

Figure 5-5. Example on how data from a sponge mapping survey can be presented. The pie chart sums up the total area of the seabed classified in the different coverage categories for either soft-bottom or hard-bottom sponges.

5.4.3 Sea-pen communities

The habitat «Sea-pen and Burrowing Megafauna Communities» is defined as a threatened habitat (OSPAR, 2010b). The habitat includes deep water sea-pen communities consisting of *Umbellula encrinus* and gatherings of for example *Kophobelemnion stelliferum* ("hanefot" in Norwegian) or other sea-pen species which can be found both in the Norwegian Sea and the Barents Sea (*Funiculina quadrangularis*, *Virgularia mirabilis*, *Pennatula phosphorea*). There is no established description of the habitat, but it is recommended that the survey aims to map important gatherings of sea pens, as well as the spatial distribution of *Umbellula*. Individual *Umbellula* should be counted, while for other sea-pen communities the following semiquantitative distribution can be used:

- 1-5 individuals per 25 m²
- 5-10 individuals per 25 m²
- 10-15 individuals per 25 m²
- >15 individuals per 25 m²

5.5 Analysis of collected material

Guidelines for analysis and recording of images and video collected during visual surveys are described in NS-EN 16260:2012.

Visual surveys will only encompass megafauna. An assessment of which species are present should as far as possible be carried out. This can be demanding for sponges, and determination of family may be the closest one is able to do. It is important to describe the diversity and not only discuss groups defined as vulnerable. Furthermore, condition and coverage degree should be described (see chapter 5.4).

Fauna diversity should be calculated on the basis of semi-quantitative density measurements for particular species/types of fauna. Differences in faunal characteristics should be compared with available information about the physical/chemical conditions at the same localities, e.g. sediment type, hard bottom patches and incidence of trawl tracks.

Only professionally qualified personnel should perform species identification. Documentation of quality control procedures, as well as species identification literature should be available and submitted on request. Databases like Worms ([World Register of Marine Species](#)) or ERMS ([European Register of Marine Species](#)) should be used to provide consistency in terms of species identification so that data is comparable.

5.6 Reporting

Visual surveys are a relatively recent development when it comes to Norwegian offshore environmental monitoring. Guidelines and requirements for reporting may change as more surveys are carried out and more experience of this method is gained. Some points that should be included in the reports are listed below, but these are to be considered as suggestions since the methodology is still being tested.

The target group for the report includes the oil and gas companies, environmental authorities, research institutions and consultancy firms. The report is to be delivered in both Norwegian and English. This is the final scientific report for a survey. It should therefore include complete documentation of the monitoring campaign, focusing on:

- field methodology and execution;
- analytical parameters;
- methods used for data analysis and quality assurance
- results and conclusions of the survey;
- issues that should be given priority in future surveys;
- assessment of the analytical methods and proposals for improvements.

5.6.1 Contents

Summary

The summary should include:

- a short description of the purpose for the survey

- a description of the field work and of the methods used
- the most important results and discussion (shown in figures and tables if necessary)
- the most important trends and comparisons with any earlier surveys or between this year's surveyed areas
- conclusions and recommendations.

Introduction

The following should be described for the surveyed area(s):

- description of the area
- field history and plans for the future
- earlier surveys summed up (table);
 - results from acoustic mapping, if available
 - biological investigations, if available.

Methods

The methods section should include the following:

- map with coordinates, map scale, depth contours, etc.;
- reasons for the choice of stations/survey lines;
- brief description of the completed field program, including time frame for conducting the survey, number of stations or surveyed areas, equipment, positioning system, any problems or deviations from the survey program, with reasons (complete field log in appendix);
- description of equipment used (for more details about requirements regarding equipment see appendix V)
- description of survey route (description of sampling design, map over and length of survey lines)
- description of methods used to characterize benthic communities, including calculations and diversity, dominance etc., as well as methods for comparing faunal structure to relevant environmental parameters (such as incidence of trawling tracks),
- principles for quality assurance routines in the field (brief if the consultancy firm is accredited for the analysis in question);
- accreditation status and proof if applicable (to be included in an appendix);
- where and how the processed material (video material, still images, databases) is stored, responsibility for the material and results and their availability.

Results and discussion

This chapter presents the results of the survey and discusses them in light of the survey's objective. Relevant findings should be summarized and presented in maps and tables, including relevant information on type of substrate, topography, fauna characteristics and anthropogenic impact for the field. Reference to the utilized map datum must be included in maps. Findings of redlisted / OSPAR habitats or other potentially vulnerable habitats should be specified (preferably with geographic position).

Overall evaluation and conclusions

The chapter should contain a brief summary of the main findings and any concluding comments regarding the environmental status on the individual fields.

Recommendations

An evaluation of the survey and of the analytical methods used should be conducted. Comments and proposals for improvements should be discussed, as well as recommendations to perform further surveys if results of the present survey indicate such a need.

5.6.2 Appendices

The appendices to the report should be delivered electronically and as a minimum include the following:

- final program for the surveys as established in agreement with the Agency
- complete field logs with date, time, position (GMS and UTM, which reference grid is used; grid zone must be specified), depth, number of grab samples and weather conditions presented in table format
- species list
- still images
- edited video presentations from each field showing transects, types of substrate, fauna and conclusions
- (resultats in GIS format)
- (data files in an Excel-document)

References

- Bakke, T., Klungsøyr, J. & Sanni, S. 2013. Environmental impacts of produced water and drilling waste discharges from the Norwegian offshore petroleum industry. *Marine Environmental Research*.
- Bale, A.J. & Kenny, A.J. 2005. Sediment analysis and seabed characterisation. In: Eleftheriou, A.; McIntyre, A.D. "*Methods for the study of marine benthos*". 3rd edition. Blackwell Science. Oxford, UK. ISBN 0-632-05488-3. pp. 43-86.
- Baršienė, J. *et al.* 2013, Environmental genotoxicity and cytotoxicity levels in fish from the North Sea offshore region and Atlantic coastal waters, *Marine Pollution Bulletin* 68, 106-116
- Borja, A., Franco, J., & Perez, V. 2000. A marine biotic index to establish the ecological quality of soft-bottom benthos within European estuarine and coastal environments. *Marine Pollution Bulletin*, 40, 1100-1114.
- Bray, J.R. & Curtis, J.T., 1957. An ordination of the upland forest communities of Southern Wisconsin. *Ecol. Monogr.*, Vol. 27, pp. 325-349.
- Clarke, K.R., Somerfield, P.J., Gorley, R.N, 2008. Testing of null hypothesis in exploratory community analyses: similarity profiles and biota-environment linkage. *J. Exp. Mar. Biol.*, 336, 56-69.
- EPA, Test method 610 - Polynuclear Aromatic Hydrocarbons. Environmental Protection Agency.
- ICES/ISO. «Workshop on biological effects of contaminants in pelagic ecosystems» (BECPELAG) - sluttrapport.
- ISO 16665:2014 - *Water quality - Guidelines for quantitative sampling and sample processing of marine soft-bottom macrofauna.*
- ISO/IEC 17025: 2005 - *General requirements for the competence of testing and calibration of laboratories.*
- JAMP Guidelines for General Biological Effects Monitoring.* OSPAR Agreement 1997-7
- JAMP Guidelines for Monitoring Contaminants in Biota.* Oslo and Paris Commissions Joint Assessment and Monitoring Programme. Agreement 1999-2, revised 2012.
- JAMP Guidelines on Quality Assurance for Biological Monitoring in the OSPAR Area* Agreement 2002-15
- JAMP Guidelines for Monitoring Contaminants in sediments.* Oslo and Paris Commissions Joint Assessment and Monitoring Programme. Agreement 2002 - 16.
- JAMP Guidelines on Contaminant- Specific Biological Effects Monitoring.* Agreement 2008 - 9.
- JAMP Guidelines for the integrated monitoring and assessment and their effects.* Agreement 2012-9
- Kålaas, J.A., Viken, Å., Henriksen, S. og Skjelseth, S. (red.) 2010. *Norsk rødliste for arter 2010* [Norwegian Red List for species 2010] Artsdatabanken, Norge.
- Lindgaard, A. og Henriksen, S. (red.) 2011. *Norsk rødliste for naturtyper 2011* [Norwegian Red List for habitat types 2011] Artsdatabanken, Trondheim.

- Martinez-Gomez, C. et al. 2012. *Biological effects of contaminants: stress on stress (SOS) response in mussels*. ICES Techniques in Marine Environmental Sciences, No. XX NS 4764:1980. *Vannundersøkelse. Tørrstoff og gløderest i vannslam og sedimenter*. Standard Norge
- NS-EN ISO 12846:2012. *Water quality - Determination of mercury - Method using atomic absorption spectrometry (AAS) with and without enrichment (ISO 12846:2012)*. Standard Norge
- NS-EN 16260:2012. *Water quality - Visual seabed surveys using remotely operated and/or towed observation gear for collection of environmental data*. Standard Norge
- NS-EN ISO 5667-19:2004. *Water quality - Sampling - Part 19: Guidance on sampling in marine sediments (ISO 5667-19:2004)*. Standard Norge
- NS-EN ISO 16665:2013. *Water quality - Guidelines for quantitative sampling and sample processing of marine soft-bottom macrofauna (ISO 16665:2014)*. Standard Norge
- OSPAR Guidelines for monitoring the Environmental Impact of Offshore Oil and Gas activities. Agreement 2004 - 11.
- OSPAR 2008. OSPAR Convention for the Protection of the Marine Environment of the North-East Atlantic. *Descriptions of Habitats on the OSPAR List of Threatened and/or Declining Species and Habitats* (Reference Number: 2008-7, Replaces agreement 2004-7).
- OSPAR 2010a. *Background document for Deep Sea Sponge Aggregations*. OSPAR Commission biodiversity series Publication Number: 485/2010.
- OSPAR 2010b. *Background document for Sea Pens and Burrowing megafauna*. OSPAR Commission biodiversity series Publication Number: 481/2010.
- Pielou, E.C., 1966. *The measurement of diversity in different types of biological collections*. J. Theor. Biol., 13:131-144.
- [Retningslinjer for innleggelse av data i MOD](#).
- Rygg B., Norling K., 2013. *Norwegian Sensitivity Index (NSI) for marine macroinvertebrates, and an update of Indicator Species Index (ISI)*. NIVA-rapport 6475-2013, 46s
- [Veileder 02:2013 - Klassifisering av miljøtilstand i vann](#). Økologisk og kjemisk klassifiseringssystem for kystvann, grunnvann, innsjøer og elver. Miljødirektoratet 2013

6. Appendices

Appendix I – Analytical parameters

Table 2-1 US Environmental Protection Agency (US EPA) list over the 16 most important PAH-components

| | | |
|---------------------------|-------|----------|
| Acenaphthene | 34205 | 83-32-9 |
| Acenaphthylene | 34200 | 208-95-8 |
| Anthracene | 34220 | 120-12-7 |
| Benzo (a) anthracene | 34526 | 56-55-3 |
| Benzo (a) pyrene | 34247 | 50-32-8 |
| Benzo (b) fluoranthene* | 34230 | 205-99-2 |
| Benzo (ghi) perylene | 34521 | 191-24-2 |
| Benzo (k) fluoranthene* | 34242 | 207-08-9 |
| Chrysene** | 34320 | 218-01-9 |
| Dibenzo (a, h) anthracene | 34556 | 53-70-3 |
| Fluoranthene | 34376 | 206-44-0 |
| Fluorene | 34381 | 86-73-7 |
| Indeno (1,2,3-cd) pyrene | 34403 | 193-39-5 |
| Naphthalene | 34696 | 91-20-3 |
| Phenanthrene | 34461 | 85-01-8 |
| Pyrene | 34469 | 129-00-0 |

¹ Storage and Retrieval number (US EPA)

² Chemical Abstract Service registry number (American Chemical Society)

* Figures for benzo (b, j, k) fluoranthenes are reported together

** Chrysene is reported together with triphenylene

Appendix II - Modified van Veen grab for collecting

sediment samples ³

Traditional sampling in connection with monitoring of petroleum activities offshore generally involves taking 8 grab loads (5 biology samples + 3 chemistry samples). In shallower water, as is the case in the southern parts of the Norwegian continental shelf, a regular van Veen grab is most appropriate. A modified van Veen grab (combined) is however also used to carry out environmental monitoring offshore. When using a slow winch and/or at bigger sampling depths (> 100m), the use of this grab sampler saves time, because the sampler's residence time in the sea is decreased. By utilizing the modified grab sampler chemistry and biology samples can be obtained from the same grab load, the number of necessary loads being thus reduced. One achieves at the same time a more direct relationship between biology and chemistry data. An important objective of these surveys is to find any correlations between measured chemical parameters and the composition of the soft-bottom fauna in an area.

³ Excerpt from DNV Energy 2007: *Grab-sampler development - Report to Biolaboratoriet no. 2007-3147*

The modified grab sampler is 0.05 m², larger than a conventional van Veen grab sampler of 0.1 m². Biology and chemistry samples may be taken from the same grab load since a divider splits the load in two. The inner walls of this model have two slots, so that the divider can be manually pressed down when the grab sampler comes on deck (Figure 6-1). As is the case with a conventional van Veen grab, the area for the biology samples is identical with 0.1 m², while the area for the chemistry samples is 0.05 m². The sampler satisfies requirements for water flow so that to avoid a "frontal wave" when it hits the bottom (ISO 16665: 2014). The screens have a 0.5 mm perforated mesh which constitutes 60% of the grab top surface

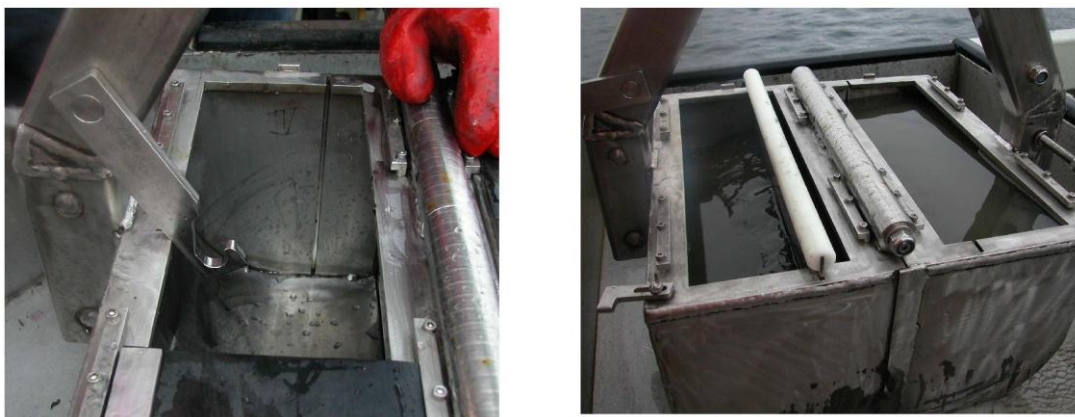

Figure 2-6. Illustrations of sliding tracks and grab sampler with divider

The sampler's shape, along with the requirement that the area for biology samples must be 0.1 m², means that the sediment sample must be at least 9 cm deep. The volume of sediment in liters at this depth will be 8 liters, thus meeting the requirement of having at least 7 liters in the sediment sample.

Table 6-1. Overview over number of liters in a sample at various sampling depths

| Cm | liter | Cm | liter | Cm | Liter | Cm | liter | cm | Liter |
|----|-------|----|-------|----|-------|----|-------|------|-------|
| 1 | 0,7 | 6 | 5,1 | 11 | 10,0 | 16 | 15,0 | 21 | 20,0 |
| 2 | 1,5 | 7 | 6,1 | 12 | 11,0 | 17 | 16,0 | 22 | 21,0 |
| 3 | 2,4 | 8 | 7,1 | 13 | 12,0 | 18 | 17,0 | 22,2 | 21,2 |
| 4 | 3,3 | 9 | 8,1 | 14 | 13,0 | 19 | 18,0 | - | - |
| 5 | 4,2 | 10 | 9,0 | 15 | 14,0 | 20 | 19,0 | - | - |

Drawings and photographs

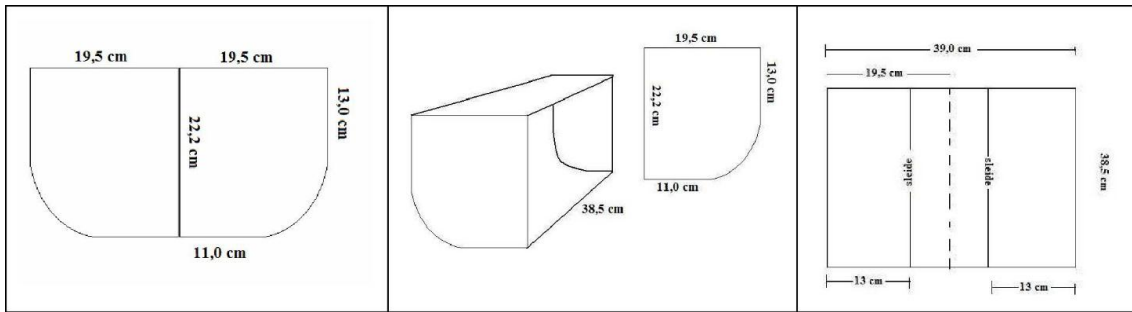

Dimensions and design of grab sampler. Left and center: from the side. Right: topside

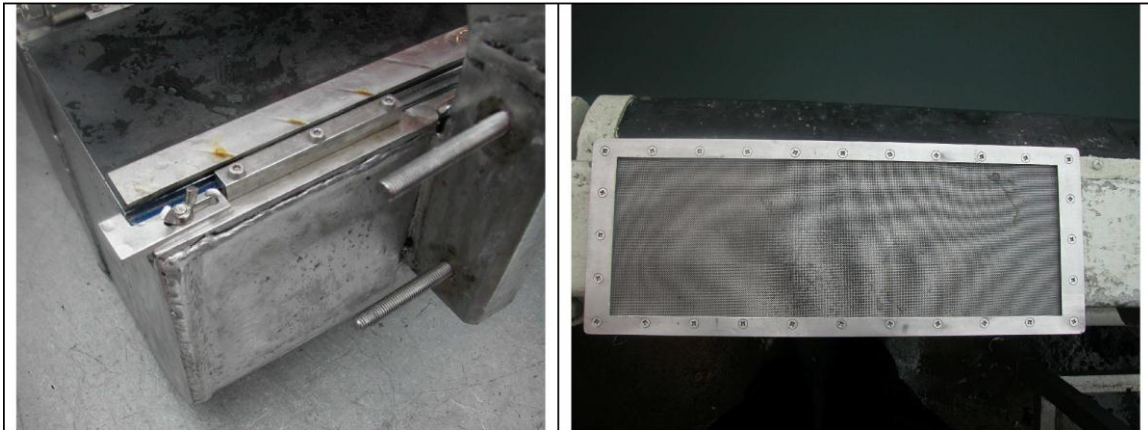

Left side: locking mechanism for the screen. Right side: screen with 0,5 mm mesh



The divider splits the sample in two so that samples can be processed independent of each other.

Appendix III – Detection limits for metals

The detection limits are established with regard to both the sensitivity of the measuring instruments and the background values registered in the sediments in the North Sea. These

detection limits (mg/kg dry sediment) depend on the quantities of sediment that are weighted. The values provided in the table below are valid for a quantity of weighted sediment of minimum 1 g.

Table 6-2 Detection limits for different metals

| Element | Detection limit mg/kg (dry sediment) |
|---------|---|
| Ba | 1,0 |
| Cd | 0,03 |
| Cr | 0,5 |
| Cu | 0,6 |
| Hg | 0,01 |
| Pb | 0,5 |
| Zn | 2,0 |

Appendix IV – Formula for calculating LSC

$$LSC > \bar{R}_{..} + t_{\alpha(1),v} \cdot s \cdot \sqrt{1 + \frac{1}{N_r}}$$

$\bar{R}_{..}$ = average of the station mean values for the regional stations

$t_{\alpha(1),v}$ = critical value from the t-distribution with one-sided t-test with level of significance α (=0.05) and $v = N_r - 1$ degrees of freedom

s = standard deviation of sedimentation between station averages

N_r = number of regional stations

$$s = \sqrt{\frac{\sum_{i=1}^{N_r} (\bar{R}_{i.} - \bar{R}_{..})^2}{N_r - 1}}$$

The standard deviation s is calculated as

where $\bar{R}_{i.}$ = mean values on the parallels of regional station nr. i .

Appendix V - Methods for delimitating affected areas

Two affected areas are to be calculated for each field: one where there is significant chemical contamination by THC (as defined by LSC values, to be calculated for THC and THC

higher than 50 mg/kg if possible), and one where there are impacts on the benthic fauna. The areas should be given in km². The calculations are based on the assumption that the affected areas are approximately elliptical. The radii of the ellipse depend on the distance along each transect where effects can be detected. The calculations are conservative, *i.e.* they give an estimate of the maximum area affected. The radii must therefore be calculated as the distance from the center of the ellipse to the innermost station where no effect is found. In many cases, this will result in an asymmetrical ellipse (see the figure below). The area is calculated in the same way in both cases:

$$\text{Area} = \pi * (a+b)*(c+d)/4$$

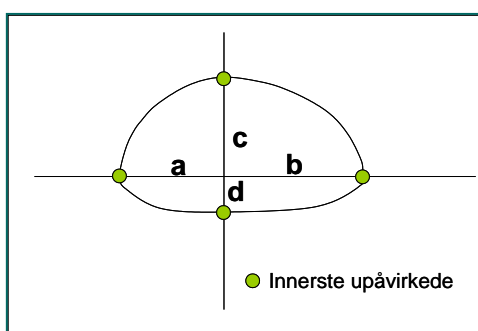

If no stations have been sampled along a transect, the radius is defined as the distance from the center to the nearest station where no effects were found in the most recent survey that covered the transect in question.

If a transect has never been surveyed, the radius is defined as the average of the other radii.

If a previous station is omitted one year its values from the last time the station was investigated may be used.

On complex fields where there are many installations and overlapping station networks, such as Gullfaks, one common elliptical area should be defined for the entire field. The radii should normally be the distance from the center to the nearest station where no effect is found, but in most cases some assessment will also be needed to define the most suitable area.

The calculation method (chosen ellipse and how the axes are defined) must be documented in the report.

Appendix VI – Recommended equipment for carrying out visual surveys

The following equipment is necessary to carry out visual surveys:

- Suitable survey vessel with dynamic positioning system (DP system)

- ROV suitable for the purpose (see below)
- Underwater navigation system/ USBL system
- Data communication (fiber optic connection between the bottom and the surface)
- High resolution video (preferably HD)
- Camera for still images
- Lasers to measure dimensions

Towed observation gear such as drop-down cameras may alternatively be used, although that is generally not recommended. A drop-down camera is not suitable for mapping previously identified targets such as potential coral reefs, pockmarks or crustal areas. A drop-down camera may be an alternative to carry out linear transects for investigating sponge communities (the system must have wave compensation and a strong enough light source)

General requirements for the ROV

- Enough thruster capacity for the purpose (adjusted depth, current velocity and so on).
- Sufficient power source to operate the equipment to be used (described below).
- Sufficient light, possible to adjust depending on the seawater conditions (particles etc.).

Depending on the survey type (pilot, mapping or trend monitoring) there will be different requirements connected to the observation gear. A smaller ROV / drop camera that does not necessarily hold quite a steady course may be sufficient for pilot surveys. To surveys carried out along established routes or having specific goals a vessel that can hold its' position faced with strong currents or cable drag and execute complicated maneuvers is necessary.

Navigational equipment

Depending on the survey type there will be different requirements connected to the accuracy of the underwater positioning system. The standard NS-EN 16260 should be observed. For mapping purposes, the accuracy should not be less than 2 m + 5% of water depth with continuous recording of positions and depths. All positions and depths must be logged together with the time reference. It is also an advantage to log additional data such as the ROV's heading, altitude, pitch and roll, and the vessel's position.

Still image camera

During mapping a still photo should be taken for every 30 meters of the seabed in addition to video, for other details see NS EN 16260. Still images are important for species identification, while video is better suited to calculate the quantitative distribution over larger areas.

Minimal requirements for the camera:

- Camera with a resolution of 2 megapixels or higher is recommended. For mapping the camera should be able to capture objects larger than 5 mm.
- A blitz/"flashgun" should be connected to the system so that it is possible to take clearer pictures.
- Possibility to choose between automatic or manual focus, as well as light sensitivity (ISO).

Advice: a camera with rapid focus and higher ISO values is recommended for taking pictures of moving organisms. Other camera features may be prioritized if the targets are mostly still ("sessile").

Video camera

Minimal requirements:

- Pan-tilt
- Zoom
- Overlay with position, time, depth, name of survey line etc.
- Possibility to choose between automatic or manual focus

It is an advantage that the observation gear has different cameras available with different light sensitivity and zoom.

Laser distance meters

There are several types of laser distance meters, both bar code and dot types. The devices' measurements are used to calculate the sizes of objects and fauna.

Description of equipment when reporting

- ROV
 - ROV specifications and supplier
 - Additional equipment, maybe also its assembly (for example light positions etc.)
 - Number and type of lights (halogen, LED or other)
 - Lasers (line- or point type, as well as distance)
 - Still image camera and video camera
 - Speed, height above the bottom, camera tilt, dimming etc.
- Survey
 - Supplier
 - Navigation system and bottom accuracy
 - Event logging/ event fix
 - Navigational screen and accompanying software
 - Utilized map datum
- Any additional equipment
 - For example ROV-samplers

Norwegian Environment Agency

Telephone: +47 73 58 05 00 | Fax: +47 73 58 05 01

E-mail: post@miljodir.no

Web: www.environmentagency.no

Postal address: Postboks 5672 Sluppen, N-7485 Trondheim

Visiting address Trondheim: Brattørkaia 15, 7010 Trondheim

Visiting address Oslo: Grensesvingen 7, 0661 Oslo

The Norwegian Environment Agency's primary tasks are to reduce greenhouse gas emissions, manage Norwegian nature, and prevent pollution.

We are under the Ministry of Climate and Environment and have over 700 employees at our two offices in Trondheim and Oslo and at the Norwegian Nature Inspectorate's more than sixty local offices.

Our principal functions include monitoring the state of the environment, conveying environment-related information, exercising authority, overseeing and guiding regional and municipal authorities, cooperating with relevant industry authorities, acting as an expert advisor, and assisting in international environmental efforts.